

Installation and Operations Manual

Part Number 40VM900006

For Commercial Use Only

CONTENTS

Installation		
	Page	
SAFETY CONSIDERATIONS	2	
GENERAL	2	
DIMENSIONAL DRAWINGS	3	
INSTALLATION CONSIDERATIONS	4	
INSTALLATION	4	
SETTING NETWORK ADDRESS	7	
Operations		
	Page	
START	7	
• Login / Brand Selection (Carrier or Bryant)	7	
• Logout	8	
• Changing the Brand	8	
• Auto Search	8	
• Home Screen Features	8	
EMAIL SETUP	8	
REPORTS	9	
• Report Screen Composition and Features	9	
USING FEATURES AND FUNCTIONS	10	
• Control / Monitor Screen Composition and Features	10	
• Monitor Screen Colors and Icons	11	
UNIT CONTROL	12	
• Control Menu	12	
• Registering Floor Plan	12	
MANAGING DEVICE	13	
SCHEDULE	14	
• Schedule Screen Composition and Features	14	
• Creating Schedules	14	
• Checking Registered Schedules	15	
• Editing Registered Schedules	15	
• Deleting Registered Schedules	15	
• Temperature Unit Change for Outdoor Units	15	
• Registering Units Automatically	15	
• Temperature Unit Change for HP and HR	15	
SETTINGS	16	
• Customer Settings	16	
• Holiday Settings	16	
• Update Firmware	16	
WEB INTERFACE INSTRUCTIONS		17
• Set Up	17	
• Logging into the Touch Screen Central Controller ..	17	
• Homepage Function Description	18	
• Changing User Name and Password	18	
• Shortcut Menu Bar	18	
• Edit Menu	20	
• User Account Management	20	
• System Status	23	

Installation

SAFETY CONSIDERATIONS

Read and follow manufacturer instructions carefully. Follow all local electrical codes during installation. All wiring must conform to local and national electrical codes. Improper wiring or installation may damage thermostat.

Understand the signal words — DANGER, WARNING, and CAUTION. DANGER identifies the most serious hazards which will result in severe personal injury or death. WARNING signifies hazards that could result in personal injury or death. CAUTION is used to identify unsafe practices, which would result in minor personal injury or product and property damage.

Recognize safety information. This is the safety-alert symbol (). When this symbol is displayed on the unit and in instructions or manuals, be alert to the potential for personal injury. Installing, starting up, and servicing equipment can be hazardous due to system pressure, electrical components, and equipment location.

GENERAL

The VRF (variable refrigerant flow) touch screen central controller is a wall-mounted, low-voltage controller that provides site-level control of multiple VRF systems. The controller allows central management of mode, setpoint, and scheduling of indoor units (IDUs).

The touch screen central controller is available for use with the VRF (variable refrigerant flow) outdoor units / systems listed in Table 1.

NOTES:

- Changes or modifications of this product not expressly approved by the party responsible for compliance could void the user's authority to operate the equipment.
- This equipment has been tested and found to comply with the limits for a Class A digital device, pursuant to Part 15 of the FCC Rules. These limits are designed to provide reasonable protection against harmful interference when the equipment is operated in a commercial environment. This equipment generates, uses, and can radiate radio frequency energy and, if not installed and used in accordance with the instruction manual, may cause harmful interference to radio communications. Operation of this equipment in a residential area is likely to cause harmful interference-in which case the user will be required to correct the interference at their own expense.

Table 1: Touch Screen Central Controller Accessory Usage

UNIT	SIZES
38VMAR Heat Recovery System	072,096,120,144, 168, 192, 216, 240, 264, 288, 312, 336
38VMAH Heat Pump System	036, 048, 060, 072, 096, 120, 144, 168, 192, 216, 240, 264, 288, 312, 336, 360, 384, 408, 432

Table 2: Components shipped with Unit





NAME	IMAGE	QTY	FUNCTION
Mounting Box		1	Plastic mounting enclosure
Mounting Plate		1	Steel plate connecting controller to front of Mounting Box
Screws (Short)		6	Used to Install Mounting Box to Wall
Screws		4	Used to install Mounting Plate on Mounting Box
Washers		8	Used to install Mounting Plate on Mounting Box (2 extra washers for fine adjustment if wall is uneven)

Table 3: Specifications

Power Supply (field provided)	Rated Voltage	24VAC, 60 Hz
	Current Requirement	1A
Dimensions (inches)	H	7-3/8
	W	10-7/8
	D	1-1/4
Total Weight	Touch Screen Controller, Mounting Box, Mounting Plate, & Screws: 2 lbs 12 oz	
Number of X/Y Bus Lines	6	
Max. Refrigerant Systems/IDUs per Line	8/64	

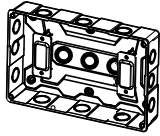
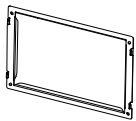
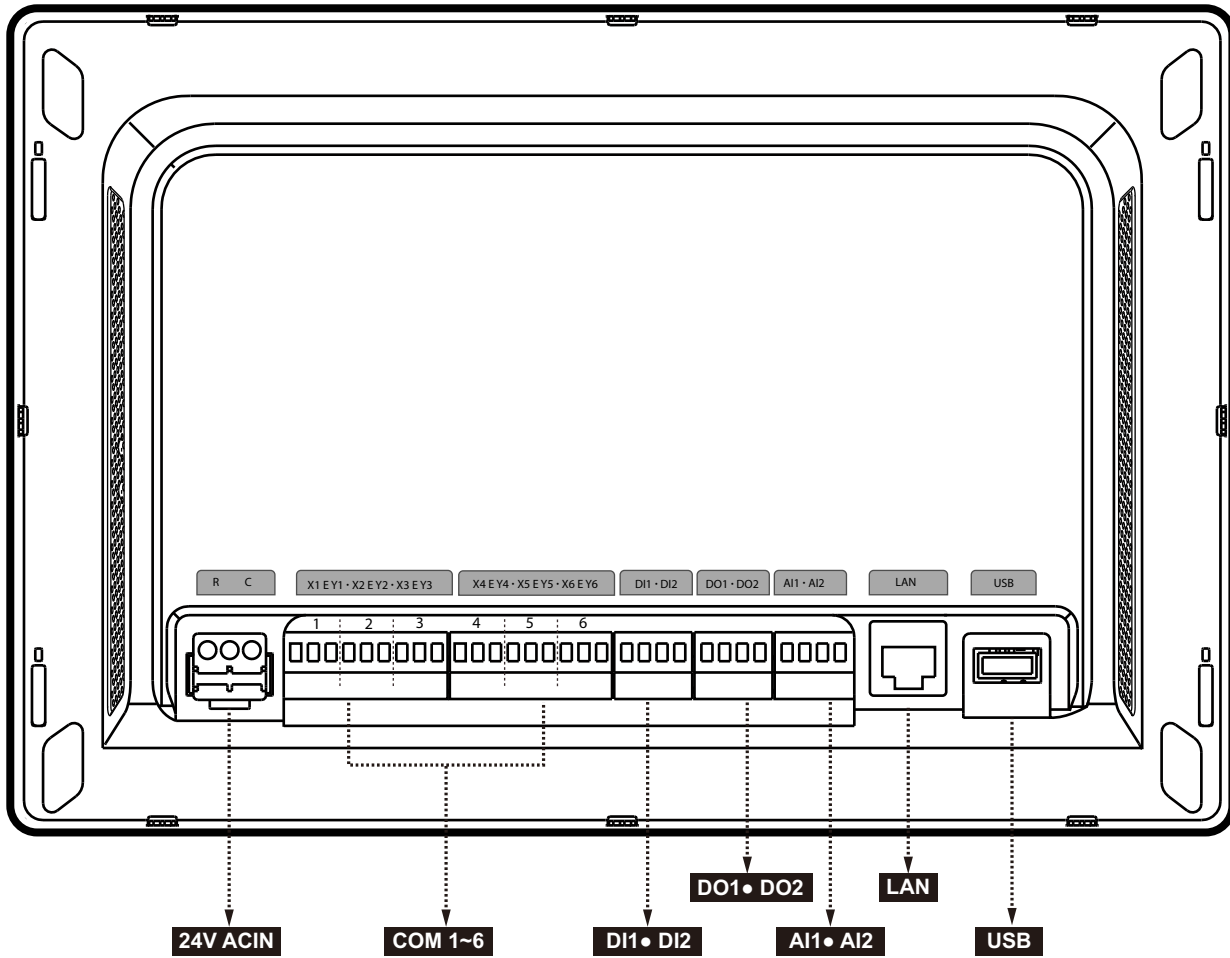

Fig. 2 — Connection Description

Table 4 — Connection Description

NAME	FUNCTION
R	24VAC power
C	24VAC common
X	X conductor, X/Y bus (no 1-6)
Y	Y conductor, X/Y bus (no 1-6)
E	Shield conductor, X/Y bus (no 1-6)
DI1	Emergency Shutdown dry contact input*
DI2	(reserved)
DO1	(reserved)
DO2	(reserved)
AI1	(reserved)
AI2	(reserved)
LAN	Local Area Network connection, Ethernet
USB	Universal Serial Bus connection for service

*Emergency Shutdown input is not suitable for life-safety applications, such as fire or smoke sequences.

INSTALLATION CONSIDERATIONS

The controller should be mounted:

- at a location that allows easy access
- on a section of wall without water or drainage pipes

The controller should NOT be mounted:

- near heat sources such as direct sunlight, heaters, dimmer switches, and other electrical devices

INSTALLATION

Perform the following procedure to install the controller:

1. Turn off all power to the outdoor units, indoor units, and MDCs.

⚠ WARNING

Electrical shock can cause personal injury and death. Before installing thermostat, shut off all power to this equipment during installation. There may be more than one power disconnect. Tag all disconnect locations to alert others not to restore power until work is completed.

⚠ CAUTION

Failure to follow this caution may result in equipment damage or improper operation.

Improper wiring or installation may damage the thermostat. Check to make sure wiring is correct before proceeding with installation or turning on unit.

2. Control Wire: Use 16 to 20 AWG (American Wire Gage), stranded twisted pair shielded 2-core wiring (copper wire). Be sure the distance between the controller and the furthest outdoor units is not more than 3937 ft.

Field-Provided 24VAC Power Wire: Use copper wire rated for the current requirement shown in Table 3. Follow all applicable electrical codes.

3. For flush-mount installation, provide a 10-1/4" by 6-5/8" opening in drywall or mounting surface to accommodate the mounting box.

⚠ CAUTION

Over-tightening the screw will cause deformation to the rear cover and LCD damage.

4. Pull all wires through drywall or surface opening, and then through knockout(s) in Mounting Box.
5. Install the Mounting Box (3) into the 10-1/4" by 6-5/8" opening in drywall or mounting surface making sure the box is flush with the wall surface. See Figure 3. Use the 6 short screws to fasten the plastic mounting box. Use plastic washers as needed for alignment and to prevent damage to components.

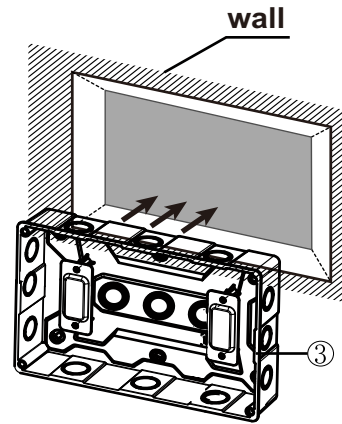

Fig. 3 — Installing the Mounting Box

6. Install Mounting Plate:

Make sure the metal hooks are facing upward. Attach the mounting plate (2) onto the mounting box (3) using the four long screws (4) and four plastic washers. Do not overtighten the screws. See Figures 4 and 5.

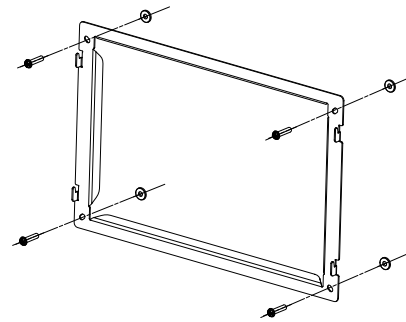

Fig. 4 — Installing the Back Plate Washers

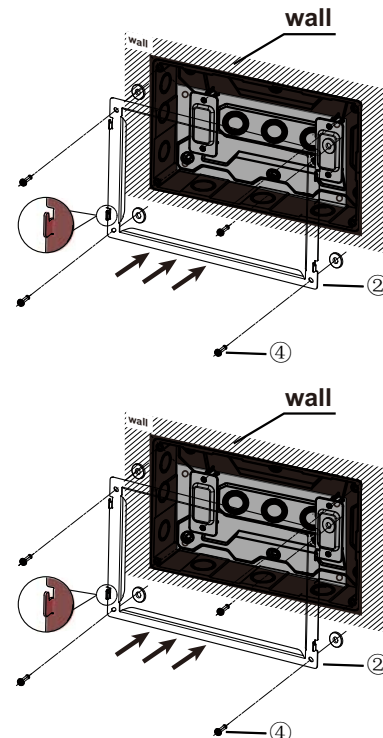

Fig. 5 — Installing the Back Plate to Box

7. Wire the Controller:

Control Wire: Use 16 to 20 AWG (American Wire Gauge), stranded twisted pair shielded 2-core wiring (copper wire).

The controller has 6 central control bus (X/Y) lines. Each line can support up to 8 refrigerant systems and 64 indoor units, maximum.

- a. Using control wire, connect outdoor units' X/Y central control bus terminals in a "daisy chain" configuration
- b. Connect the terminating end to the Central Controller's designated X/Y line (#1 through 6).
- c. For larger Heat Pump systems with dual or triple modules on a refrigerant system, wire X/Y daisy chain only to the Header outdoor unit of each refrigerant system.

See Figure 6.

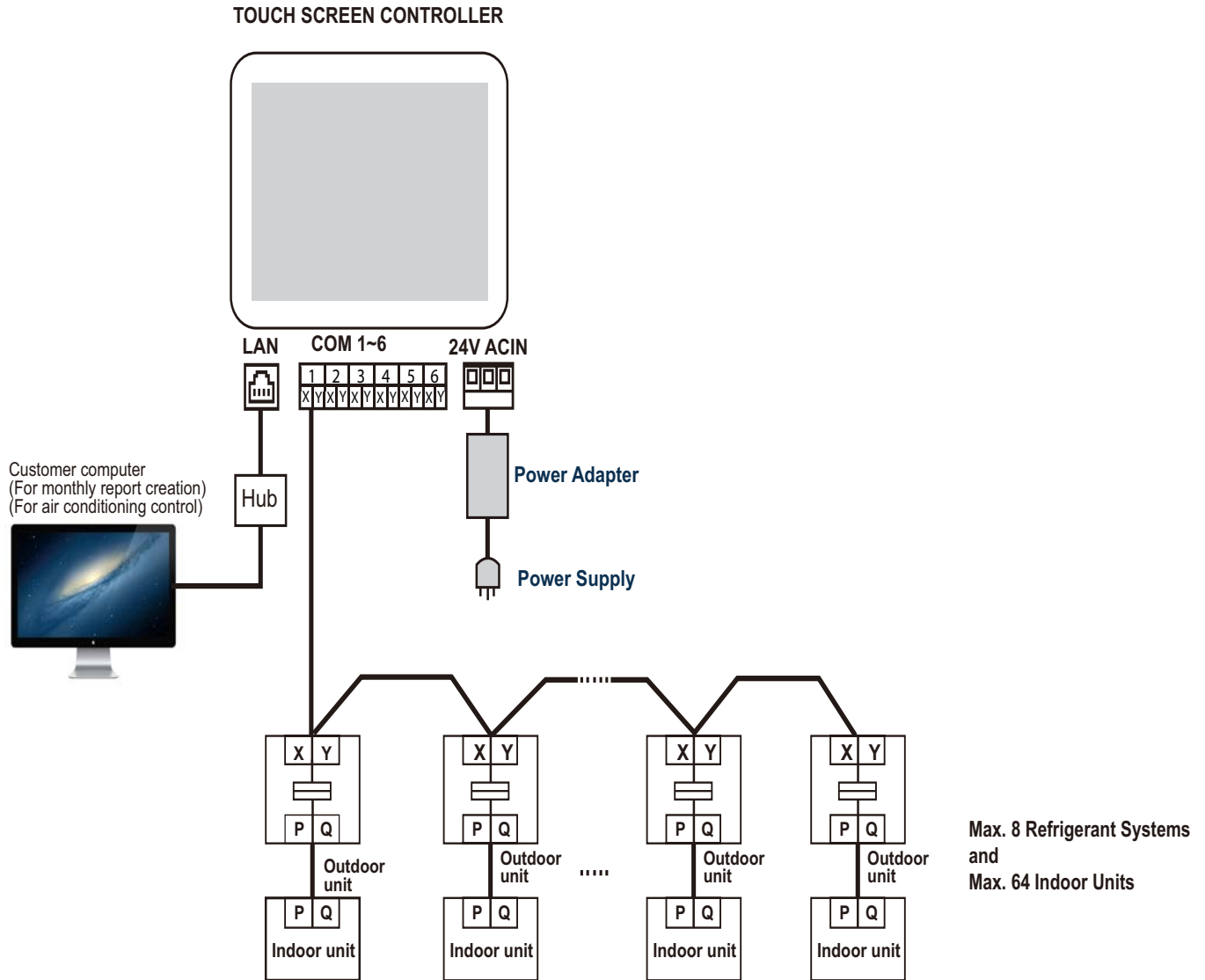

Fig. 6 — System Wiring Diagram

Connect field-supplied 24VAC power (copper wire) to R and C terminals. Connect Ethernet to LAN where applicable.

8. Install the Controller:
 - a. After wiring, install the controller (1) onto the mounting plate.
 - b. Position the holes over the metal hooks and slide down to lock into place.
- See Figure 7.

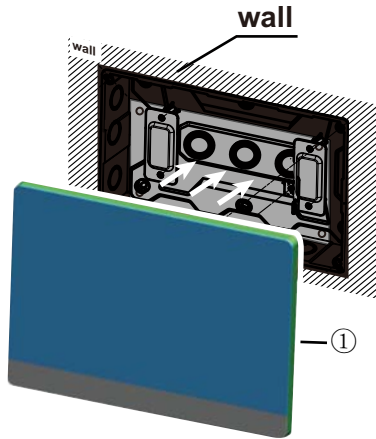

Fig. 7 — Installing the Controller
SETTING NETWORK ADDRESS

- a. Make sure each outdoor unit/refrigerant system has its own unique network address: 0-7.
- b. Set by turning rotary encoders shown below (ENC4 for 3-Phase Heat Pump and Heat Recovery, ENC2 for single Phase Heat Pump).

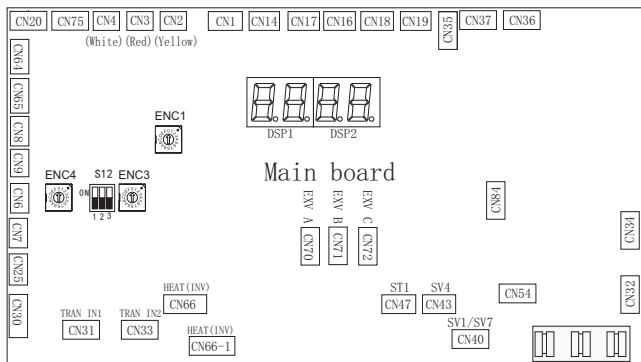

Fig. 8 —Heat Pump ENC4

- c. For larger Heat Pump systems with dual or triple modules, set all addresses the same for each module within the refrigerant system.

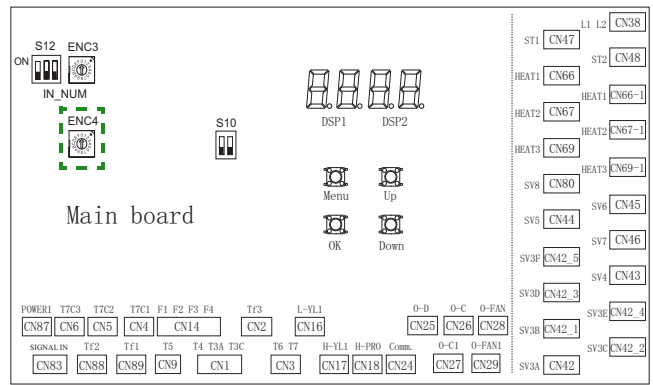

Fig. 9 —Heat Recovery ENC4

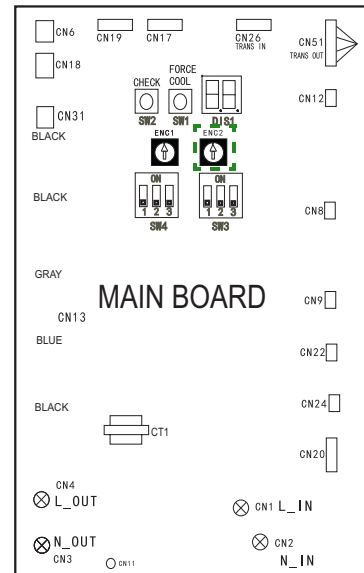

Fig. 10 —Single Phase ENC2

Operations

START

Login / Brand Selection (Carrier or Bryant) —

1. Power on the controller. The following splash screen will be briefly displayed:



Fig. 11 —Initial Screen when Powered On

The following screen will be displayed:

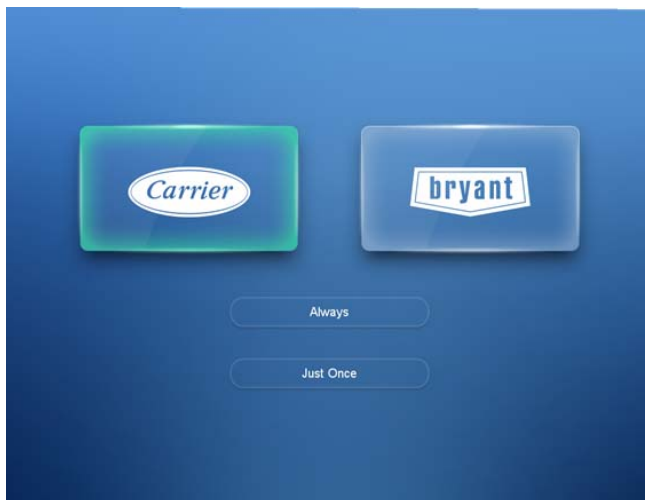

Fig. 12 —Brand Choice Screen

2. Select "Carrier" or "Bryant," and select "Always" or "Just Once."

One of the following screens will be displayed depending on the user selection:

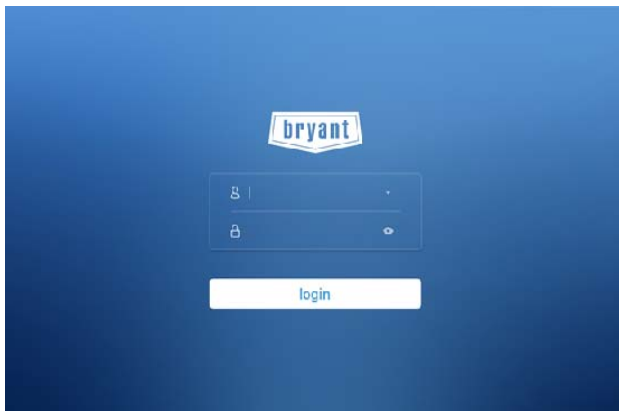

Fig. 13 —Bryant Login Screen

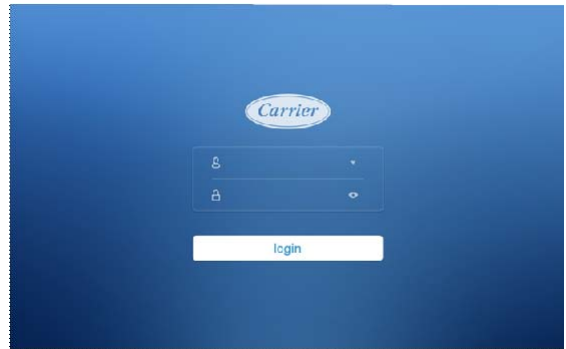

Fig. 14 —Carrier Login Screen

NOTE: If "Always" is selected, the brand chosen (Carrier or Bryant) will be always displayed unless the user selects the other brand in step 2 in the section, "Changing the Brand."

3. Login to TSCC using the default user name and password.

User Name: superAdmin

Password: 66668888

One of the following Home Screens will display depending on the user selection:



Fig. 15 —Bryant Home Screen



Fig. 16 —Carrier Home Screen

Logout —

On the top right of the home screen, select [Logout].



Fig. 17 —Home Screen - Logout

Changing the Brand —

1. Select “Setting” > “Hardware Testing.”

The following screen will display:

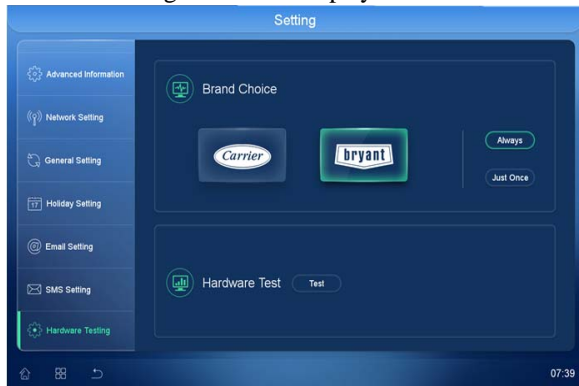

Fig. 18 —Brand Choice – Hardware Testing Screen

2. Select “Carrier” or “Bryant,” and touch the [Back] icon.

The selected brand will be displayed.

Auto Search — The Touch Screen Central Controller can automatically search and connect to the system's connected units. Devices connected to the controller are automatically searched for and registered. You can register a device automatically as follows. See Figures 19 and 20.

1. In the main menu, click the [Install] menu icon.
2. Click the [Auto Search] button. See Figure 20.



Fig. 19 — Auto Search

Home Screen Features —



Fig. 20 —Home Screen Features

Table 6 —Home Screen

Number	Item	Description
1	Time	Display date and time.
2	Running Status	Number of units in operation.
3	History	Display operation history.
4	Home	Return to home screen.
5	Main Menu	Main menu.
6	Today's Schedule	Display current schedule for the day.

EMAIL SETUP

Set up the email account in order to send out the report.

NOTE: Report emails will be sent from the following address: NOREPLYCBVRF@163.com. Report emails will be sent to the email account that is set up in the following steps.

1. Select “Email Setting” from the Settings menu.

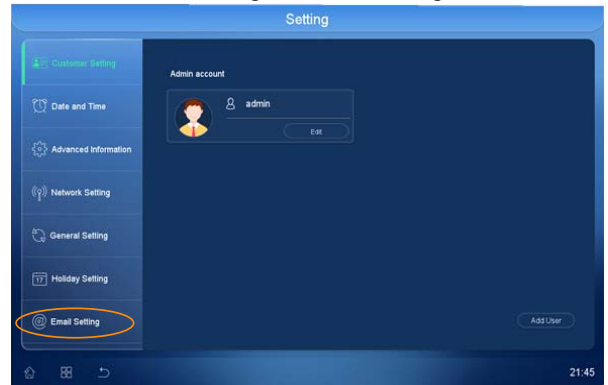

Fig. 21 —Settings Menu

2. Enter the following into the email set interface.

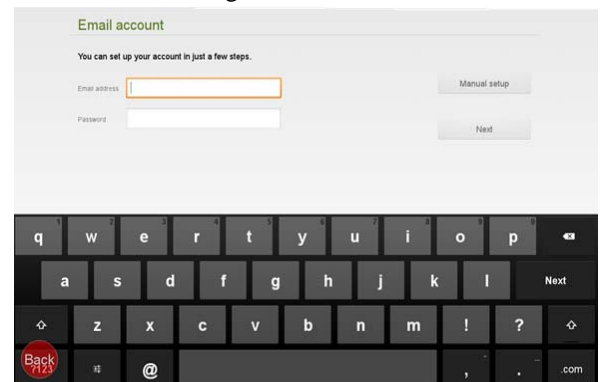

Fig. 22 —Email Setup

- Ensure that your email account has open POP3/IMAP/SMTP service.

NOTE: It may be necessary to contact your email service provider to confirm email account details such as server, security type, port, etc.

Input email address and password, and click Next.

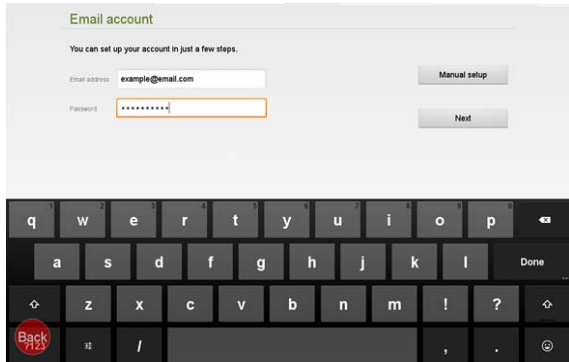

Fig. 23 —Email Address and Password

NOTE: If the red [Back] icon is covering characters needed to set up the email address and password, press and hold the icon and move it to a different area.

- Select the email service (use POP3 as example).

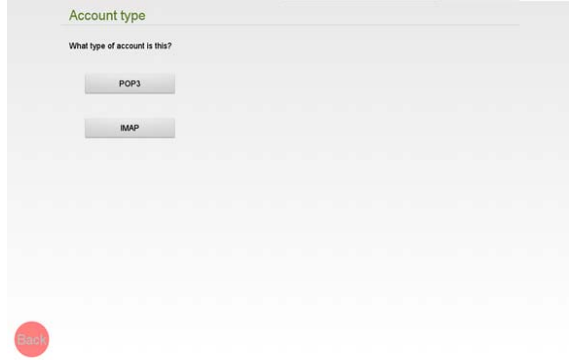

Fig. 24 —Email Account Type

Fill in the corresponding content according to the service provider and complete the requirements.

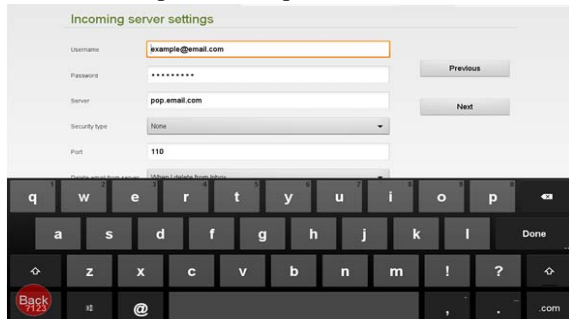

Fig. 25 —Populate Content

REPORTS

Report Screen Composition and Features —

Figures 26 and 27 and Table 7 summarize the icons and features within the report menu.



Fig. 26 —Statistics Screen

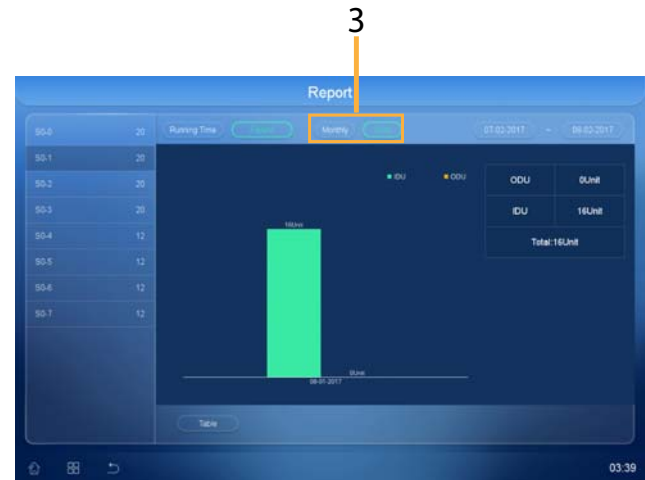

Fig. 27 —Monthly and Daily Icons

Table 7 —Statistics Screen Details

Number	Item	Description
1	System list	Displays the unit group list.
2	Statistics items	[Running Time] Icon: You can check the operating time of each group and the total operating time for indoor units. [Failure] Icon: You can check error code history for the group.
3	Query unit	[Monthly] Icon: Queries on a monthly basis. [Daily] Icon: Queries on a daily basis.
4	Query period selection area	Selects the period that you want to query statistical data.
5	Displays statistics information	Statistics data per period: Displays failure static of query or operation time statistics and graphs.
6	[Table/Graphic] icon	Converting statistics data view: Table: Views the queried statistics data in a table format. Table: Views the queried statistics data in a graphic format.
7	[Email] icon	Sends the queried statistics data by email.
8	[Save to USB] icon	Save the statistics data to a USB memory stick.

USING FEATURES AND FUNCTIONS

Control/Monitor Screen Composition and Features —

Touch the Control icon in the bottom left corner of the main screen. Figure 28 will be displayed.

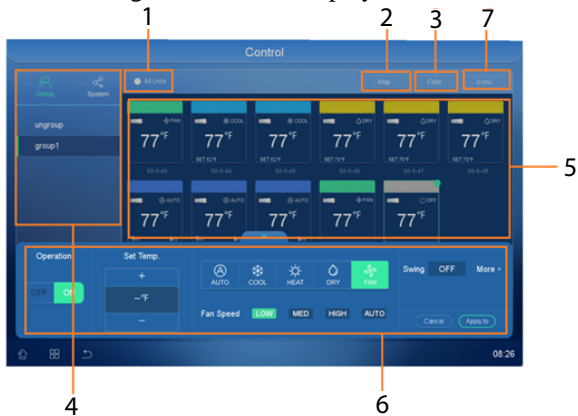

Fig. 28 —Control/Monitor Screen

Table 8 —Control/Monitor Screen Details

Number	Item	Description
1	Select/Deselect All	Select/deselect all units in a group.
2	[Map] icon	View floor plans of a group.
3	[Filter] icon	Select which unit types are displayed for monitoring and control.
4	Group List	Checks unit group listings.
5	Monitoring Screen	Checks the control status of a unit.
6	Control Panel	<ul style="list-style-type: none"> Displays the unit control menu The unit control box shows different menus depending on the unit.
7	View Type Selection	Select a view type for the monitoring screen.

The Control/Monitor menu has three types of views (icon, simple, and detailed). Figure 29 shows the screen composition and features per view type.



Fig. 29 —Control Menu - Iconic/Table Selection

ICON — The control status is shown in icons. The device icon is shown below (Figure 30).

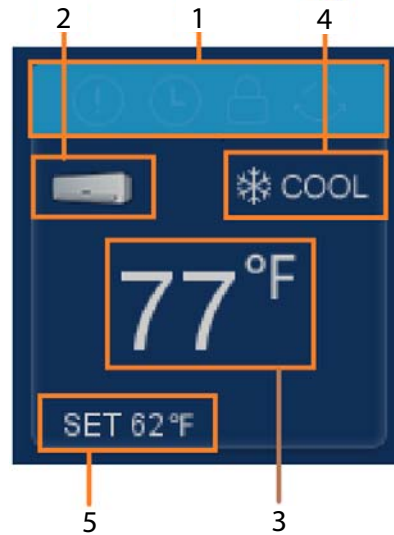

Fig. 30 —Icon View

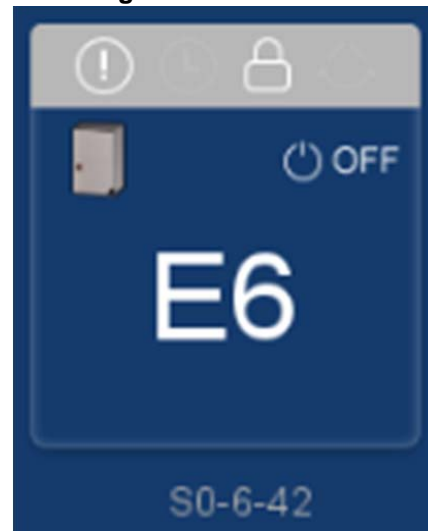

Fig. 31 —Error Code

Table 9 —Icon Details

Number	Item	Description
1	[Operation Mode and Device Status] Icon	The color at the top of the icon box shows the current operation mode. The status of the unit is indicated as an icon.
2	[Device] Icon	The unit to be controlled is indicated as an icon. The unit shown may not represent the appearance of the actual unit.
3	Current Temperature	Displays the room temperature.
4	Operation Mode	Displays the operation mode of the unit.
5	Desired Temperature	Displays the setpoint.

Monitoring Screen Colors and Icons —













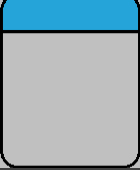

Color	Icon	Operation Mode
	 AUTO	Auto
	 COOL	Cooling
	 HEAT	Heating
	 DRY	Dehumidification
	 FAN	Fan
	 OFF	OFF
	 OFFLINE	Offline

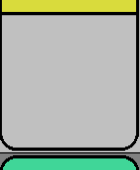
Fig. 32 —Box Colors and Operation Mode Per Icon

Table 10 —Control Unit Icons

Icon	Device type
	LDUCT
	AHU
	HDUCT
	MDUCT
	OA
	HWALL
	F-CON
	CASS, CCASS
	ERV
	UC/FL
	HP
	HR
	SHP

UNIT CONTROL

Control the unit as follows:

1. From the main menu, touch [Control].
2. Touch the unit group that you want to control from the group list.
The display will show units that are being controlled.
3. Touch the unit that you want to control.
To select all units, click the button at the top.
The unit control area is displayed at the bottom of the screen.
4. In the unit control box, set the control status of the unit.
The unit control box shows a different menu for each unit.

Control Menu — The control menu contains the mode control panel and lock control panel.

MODE CONTROL PANEL — The following screen shows the indoor unit control menu and features. Once you have finalized the settings, touch [Apply to].

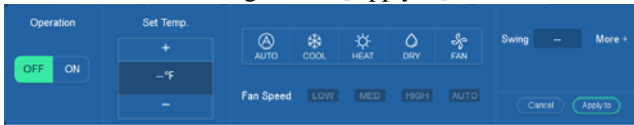

Fig. 33 —Box Colors and Operation Mode Per Icon

Table 11 —Mode Control Panel Details

Item	Description
Operation	[ON] icon: Starts the operation of the unit.
	[OFF] icon: Stops the operation of the unit.
Set Temperature	Touch [+] / [-] to set the temperature.
Mode	[AUTO] icon: Evaluates the operating environment conditions and automatically sets the optimum mode.
	[COOL] icon: Operates in Cooling Mode.
	[HEAT] icon: Operates in Heating Mode.
	[DRY] icon: Dehumidifies during high humidity days. You cannot set the fan speed in this mode.
Continuous Fan Operation	[FAN] icon: You cannot set the temperature in this mode.
Fan Speed	[LOW] icon: Slow fan speed.
	[MED] icon: Medium fan speed.
	[HIGH] icon: High fan speed.
	[AUTO] icon: Fan speed automatically adjusts between Low, Med, and High speeds.
Swing	[on] icon: Turns on automatic oscillation of the louvers.
	[off] icon: Turns off automatic oscillation of the louvers.
More	Control panel for lock control.

LOCK CONTROL PANEL —

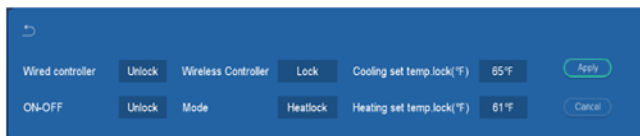

Fig. 34 —Lock Control Panel

NOTE: When you turn on the TSCC's emergency stop switch, you cannot use the remote controller to command the indoor units immediately.

Table 12 —Lock Control Panel Details

Item	Description
Wired Controller Lock	[Unlock] icon: Disables the lock.
	[Lock] icon: Disables wired controller for all features.
	[--] icon: Keep current states.
Wireless Controller Lock	[Unlock] icon: Disable the lock.
	[Lock] icon: Disables remote control for all features.
	[--] icon: Keep current states.
On/Off Lock	[Offlock] icon: Disable starting operation.
	[Onlock] icon: Disable stopping operation.
	[Unlock] icon: Disable the lock.
	[--] icon: Keep current states.
Mode Lock	[Heatlock] icon: Disable mode changing except heating.
	[Coollock] icon: Disable mode changing to heating.
	[Unlock] icon: Disable the lock.
Cooling Set Temp. Lock	[Temperature] icon: Set the lower limit temperature range (62°F~86°F).
	[Unlock] icon: Disable the lock.
	[--] icon: Keep current states.
Heating Set Temp. Lock	[Temperature] icon: Set the upper limit temperature range (54°F~86°F).
	[Unlock] icon: Disable the lock.
	[--] icon: Keep current states.

NOTES:

1. Do not simultaneously send the mode lock command and the on/off lock command. Wait 90 seconds between commands.
2. When the temperature unit (°C or °F) of the outdoor unit changes, the corresponding lock for the cool temperature set and the heat temperature set of the indoor unit needs to be set before it can take effect.
3. If the indoor unit was locked by the central controller and the central controller fails, the indoor unit must be unlocked using special software, so contact customer service.

Registering Floor Plan — From the Control/Monitor menu, you can register floor plans to identify and locate each unit and unit group. On the floor plan, you can register space information and the location of the installed unit.

1. Locate the image to map, and name it as a .png file.
2. Using a local computer, create a folder, and name it "Map."
3. Move the .png file into the folder.
4. Copy the "Map" folder into a USB device.
5. Insert the USB device into the TSCC USB port.
6. In the main menu, touch [Control].
7. Select the unit group that you want to monitor from the group list.
The monitoring screen for the device is displayed.
8. Touch [Map].



Fig. 35 —Registering Floor Plan

8. Touch [Add drawing] to add new maps:
The Open Floor Plan window will be displayed.
9. Select a desired floor plan from the Open Floor Plan window, and click [Confirm].

NOTES:

To add a floor plan, you can only use .png file format. An image size of 500 KB or less is recommended. The image resolution must be between (800 x 480) and (1280 x 800).



Fig. 36 —Floor Plan Layout

9. In the unit list, touch and hold a device to select what you want to display on the floor plan. Drag the device location on the plan.
10. To delete a unit from the plan, hold and drag it out of the plan.

MANAGING DEVICE

Use the following procedure to manage the information for a device added to the system.

ADDING GROUPS —

Follow these steps to add a new group.

1. In the main menu, touch [Install].
2. Touch [Grouping].



Fig. 37 —Adding Groups

3. Touch [Edit Group].

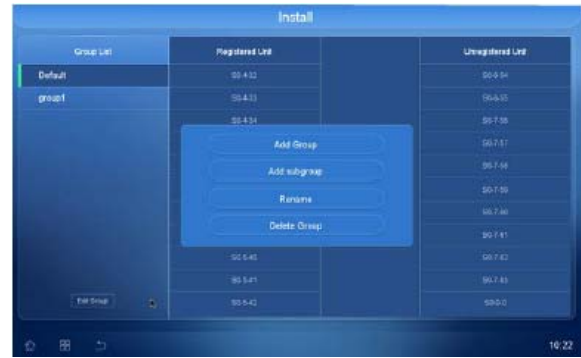

Fig. 38 —Editing Group Screen

4. In the image above, touch [Add Group]. To add subgroup, touch [Add Subgroup].
5. A screen will be displayed allowing the user to type a group name. Use the touch keyboard to enter a group name and touch [Confirm].
The group is added to the group list.

ADD DEVICES INTO GROUPS

1. In the main menu, touch [Install].
2. Touch [Grouping].
3. In the non-registered device area, touch a device to add to the new group and touch [Add].
The selected device is moved to registered device area.
4. In the registered device area, select a device to extract out of the group and touch [Extract].

CHANGING THE GROUP NAME

1. In the main menu, touch [Install].
2. Touch [Grouping].
3. In the device management list, select the group that requires a name change.
4. Touch [Edit Group].
5. In the window displayed above, touch [Rename].
6. Use the touch keyboard to enter a new group name and touch [Confirm].
The group name is changed.

DELETING GROUPS —

1. In the main menu, touch [Install].
2. Touch [Grouping].
3. In the device management list, select the group that you want to delete.
4. Touch [Edit Group].
5. In the window displayed above, touch [Delete Group].
6. When you are prompted to confirm the deletion, touch [Sure].
The selected group is deleted and the tab removed.

SCHEDULE

The Schedule feature allows you to program the operation of the unit. If a unit must follow a certain schedule, you can program the unit to operate only at scheduled times. Scheduled units are not activated unless programmed to do so and are managed centrally. This can significantly reduce energy consumption.

Schedule Screen Composition and Features —



Fig. 39 —Schedule Screen

Table 13 —Schedule Screen Details

Number	Item	Description
1	[Today] Icon	Display today's date, the current week, or the current month.
2	Dates	Displays the selected date. Use [Left Arrow] or [Right Arrow] to the previous/next date.
3	View Type	WEEK button: Converts to Week View. MONTH button: Converts to Month View.
4	[All] Icon	View full schedule list.
5	Calendar	Displays the schedules for the selected dates.
6	Schedule List	Displays registered schedules by execution time (24 hour).
7	[Add Schedule] Icon	Registers new schedules.

Creating Schedules — You can configure and add a schedule for a unit.

1. In the main menu, touch [Schedule].
2. Touch [Add Schedule].
The Add Schedule window opens.
3. In the group list, touch a group for which a schedule is applied.

The selected unit is displayed in the applied unit area of the control command configuration.

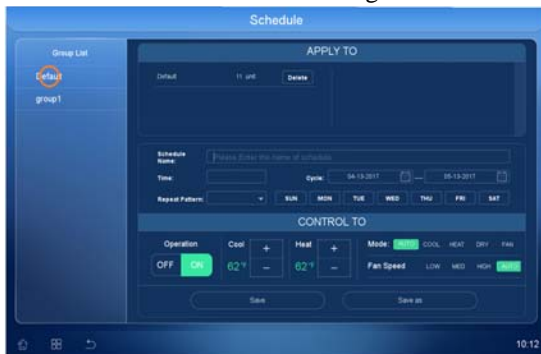

Fig. 40 —Add Schedule Screen

4. Configure the schedule information that controls the unit.

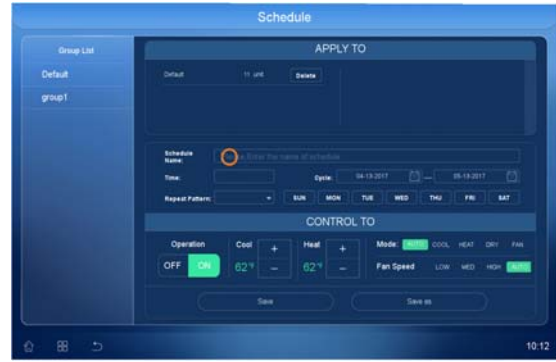

Fig. 41 —Schedule Configuration Screen

Table 14 —Schedule Configuration

Item	Description
Schedule Name	Touch the input box. Use the displayed touch keypad to type in a name for the schedule.
Time	Touch the time area, and select the desired time.
Period	Touch the period area, and select the desired period.
Repeat pattern	Touch the Repetition Pattern area, and select a desired pattern.
	Select Day: Selected days the schedule will be performed. Everyday: Applies the same schedule Everyday. Mon - Fri: Applies a schedule repeatedly from Monday to Friday.
Save/Save as	Configure the device control status, and touch the [Save/Save as] button.

NOTES:

1. When the central controller regulates several schedule plans, the cooling setpoint for the outside air unit (50°F-61°F) does not apply to other standard indoor units because the central controller protects against unsuitable temperatures.
2. After the central controller is powered on or restarted, the schedule will not be performed for the first three minutes. The time of the schedule will begin on the fourth minute.

Checking Registered Schedules —

1. In the main menu, touch the [Schedule] menu icon.
2. In the Date area, touch the [◀]/[▶] icons to select a schedule search period.
3. To check schedule details, touch the schedule you want to check in the schedule list.

Schedule details are displayed.

Editing Registered Schedules —

1. In the main menu, touch [Schedule].
2. Touch the schedule you want to modify from the schedule list.

Schedule details are displayed.

3. Touch [Edit].
The schedule configuration screen is displayed.
4. Modify the schedule information and device control configuration.
5. Use the central controller to power on and confirm it is [Save] or [Save As].

The changed data will be saved.

Deleting Registered Schedules —

1. In the main menu, touch [Schedule].
2. Touch the schedule you want to delete from the schedule list.

Schedule details are displayed.

3. Touch [Delete].
The schedule configuration screen is displayed.
4. Touch [Sure].
The selected schedule is deleted.

Temperature Unit Change for Outdoor

Units — The refrigerant systems connected to the central controller must have the same temperature unit (°C or °F).

1. Disconnect all ODU's XYE connection from the central controller.
2. Use Auto Search to delete the previous data.
3. Change all ODU temperature units to °C or °F. The temperature units must be the same.
4. Use Auto Search in the central controller to search for these systems again.

You can add a unit or change settings of a registered unit.

Registering Units Automatically — Units connected to the TSCC are automatically searched and registered. Register a unit as follows:

1. In the main menu, touch [Install].
2. Touch [Auto Search].



Fig. 42 —Auto Search Screen

Temperature Unit Change for HP and HR —

For Heat Pump and Heat Recovery outdoor unit temperature change, the default temperature is in Fahrenheit.

1. Press [Menu] for five seconds to choose the parameter setting.
2. Press UP/DOWN to select the items.
3. Press OK to confirm.

nb_	Temperature unit selection	nb1	Temperature Unit: °C
		nb2	Temperature Unit: °F

4. For Single Phase Heat Pump (Mini VRF) temperature unit change, Switch 4 must be:
 - OFF, OFF, OFF for Fahrenheit.
 - OFF, OFF, ON for Celsius.

Table 15 —Fahrenheit and Celsius Switch Settings

<p>ON SW4 1 2 3</p>	Fahrenheit temperature (factory settings)
<p>ON SW4 1 2 3</p>	Celsius temperature

SETTINGS

This section explains how to configure the system environment for user convenience and how to check an existing configured environment.

Customer Settings — Only admin accounts are able to change user environments.

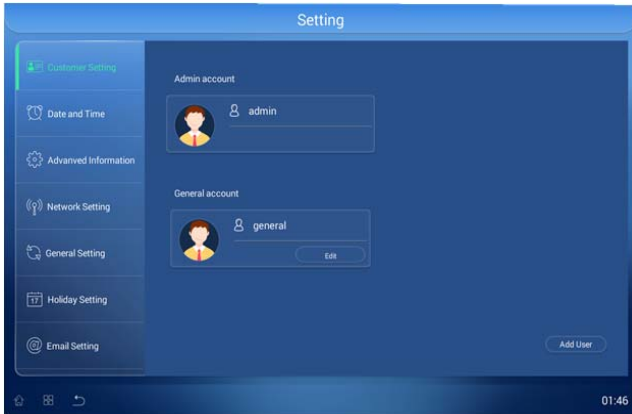

Fig. 43 —Customer Setting Screen

Table 16 —Customer Settings

Item	Description
Add user	Add new system users.
User Management	[Edit] Icon: Changes user information or delete a user.

ADD USER —

1. In the main menu, touch [Setting].
2. In the Settings list, touch [Customer Setting].
3. In the detailed settings list, touch [Add User].
4. When the [Add a New User] screen displays, enter the user information.
5. Click [Confirm].

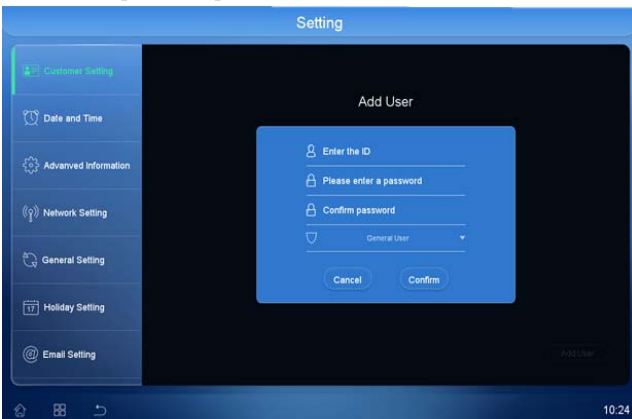

Fig. 44 —Add User Screen

- ID: Enter the user's ID for the email server.
- Password: Enter the login password.
- Password 'Confirm': Re-enter the password.
- User Role: Select the user permission you want.

DELETE REGISTERED USER INFORMATION —

1. In the main menu, touch [Setting].
2. In the Settings list, touch [Customer Setting].
3. In the user list, touch [Edit] for the user information you want to delete.
4. Touch [Delete] for the user information you want to delete.

EDIT REGISTERED USER INFORMATION —

1. In the main menu, touch [Setting].
2. In the Settings list, touch [Customer Setting].
3. In the user list, touch [Edit] for the user information you want to edit.
4. To complete the user edit, click [Confirm].

Holiday Settings — This section explains how to register an exception date or how to delete a registered date.

ADD EXCEPTION DATE —

1. In the main menu, touch [Setting].
2. In the Settings list, touch [Holiday Setting].
3. Select the exception date by touching the date in the calendar.

To complete Exception Date Configuration, touch [Yes].

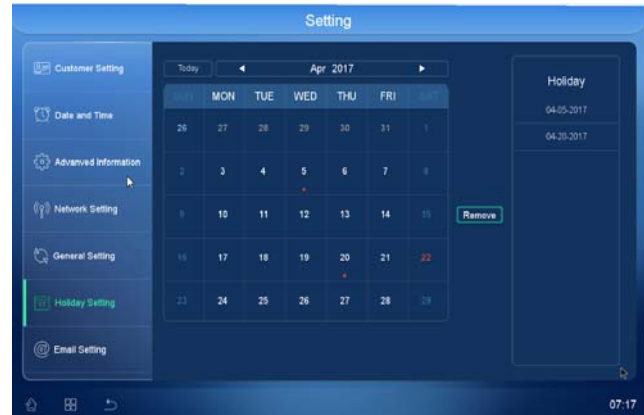

Fig. 45 —Holiday Settings Screen

DELETE REGISTERED EXCEPTION DATE —

1. In the main menu, touch [Setting].
2. In the Settings list, touch [Holiday Setting].
3. Select the exception date by touching the date in the Holiday area.
4. Touch [Extract] to delete the exception date.

NOTE: The time format of the central controller is fixed at MM-DD-YY, and cannot be changed.

Update Firmware — You can upgrade the current version of software as follows.

1. Obtain a USB with the file, “update.apk”
2. Connect the USB to the controller.
3. In the main menu, touch [Settings].
4. In the Settings list, touch [Advanced Information].
5. Touch [Check].

The controller will search the update file named “update.apk” in the USB memory.

WEB INTERFACE INSTRUCTIONS

Set Up —

Make sure the touch screen central controller and the computer are on the same local area network.

1. Under Setting/Network Setting, set the controller's IP address, subnet mask, and default gateway. Typically, Ethernet with Static IP is selected. Make note of the IP address for Web login.

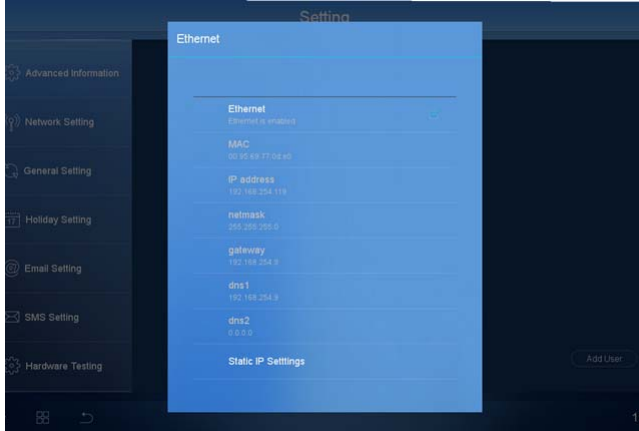

Fig. 46 —WIFI

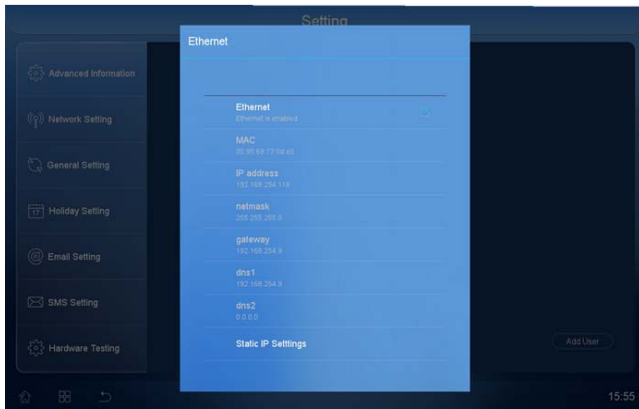

Fig. 47 —Ethernet

2. Input the Controller's IP address in the computer's web browser. Log in with the User Name and Password.

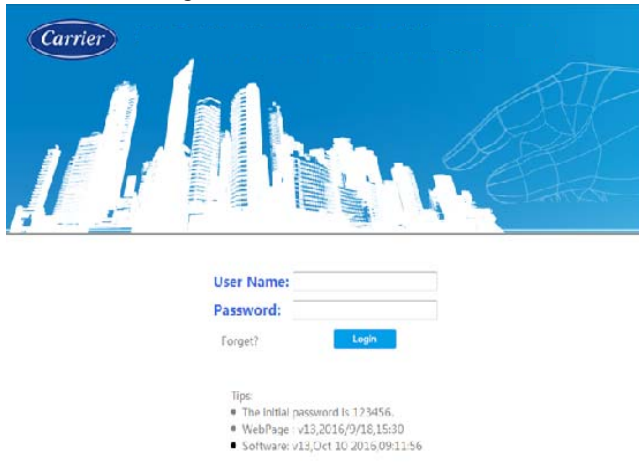

Fig. 48 —Login Screen

NOTES:

- The computer system must support Windows 7 version (32 bit, 64 bit) and above.
- The browser must support version IE9 and above.
- Google Chrome must be version 18.0 or above.
- Firefox must be version 1.5 or above.
- The computer screen resolution must be at least 1280 x 800.

Logging into the Touch Screen Central

Controller — The touch screen central controller provides one Administrator and 384 users accounts. The administrators user name is Admin. The administrator's original password is **123123**. The user's original password is **123456**.

1. Administrators and users log into the system using the original password. The following message displays:



Fig. 49 —Change Password Prompt

2. Click [OK], and the following screen displays:

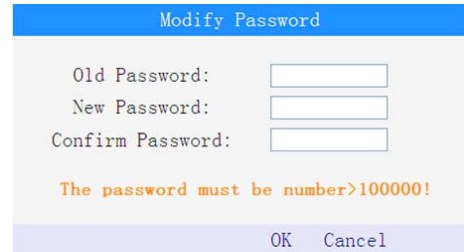

Fig. 50 —Modify Password Screen

3. Input the information to change your password.

Table 17 lists the privileges for the administrator and the general users.

Table 17 —Administrator/General User Privileges

Administrator	General User
Makes system settings	Cannot make system settings
Monitors all the air conditioning equipment	Only monitors designated indoor air unit
Area management	Only the specified area can be displayed
User rights management	N/A

This interface can show the current firmware version, which is divided into the web interface version and the software version. Firmware, including web interface and software, can be upgraded with administrator privileges in the system settings. The upgraded version number is displayed in the login screen.

- If you forget your login password, click “Forgot?” See Figure 51. The following prompt will be displayed:

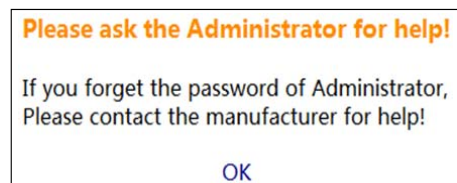

Fig. 51 —“Forgot?” Password Prompt

- If the normal user login password is lost, contact the administrator to reset it.
- If the administrator login password is lost, contact the manufacturer to restore the factory settings.

Homepage Function Description —

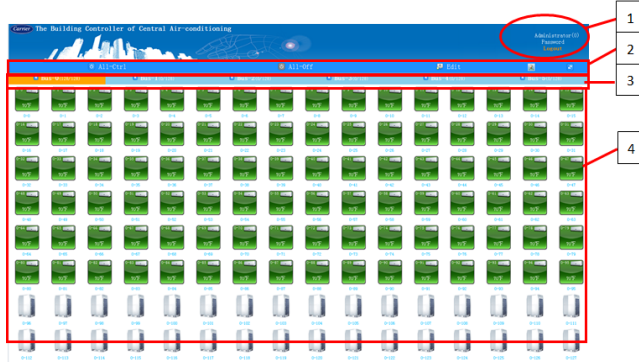

Fig. 52 —Administrator Login

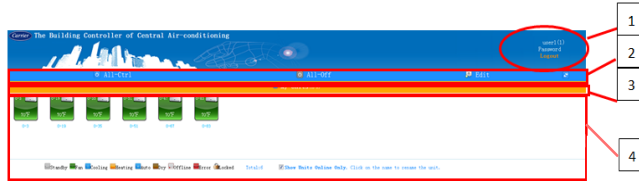

Fig. 53 —User Login

FIGURE 41 AND 42 CALLOUTS —

1. Current user information
2. Shortcut menu bar
3. Area bar
4. Equipment status field

NOTE: By default, the Area Bar displays 6 areas: Bus 0 through Bus 5. Physically, these correspond to the systems connected to the Controller's XYE Bus ports. Bus 0 shows units on the XYE Bus 1. Bus 1 shows units on XYE Bus 2, etc.

Changing User Name and Password —

[Current user information] displays the name of the current logged-in user. See Figures 52 and 53 (callout 1) above.

5. For normal users, click the name to rename it.

NOTE: An administrator cannot be renamed. The numbers in brackets represent the user's serial number. If a regular user tries to rename the Administrator, the following message will be displayed:

“Sorry, you can't rename the Administrator!”

6. Click [OK].

The following will be displayed to rename a normal user:

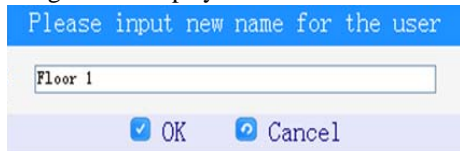

Fig. 54 —Rename Normal User

7. Click [Password] to change the password.



Fig. 55 —Change Password Screen

After the password is changed, a verification screen is displayed, and the system returns to the login screen.



Fig. 56 —Verification of Password Modification

Shortcut Menu Bar —

This provides functions of equipment monitoring and a shortcut menu. The administrator has configuration of the system settings menu, which normal users do not have.

ALL-CTRL — Sends a unified set of commands to the selected area of all VRF units:

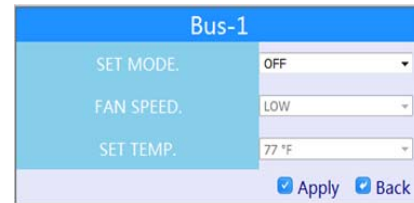

Fig. 57 —ALL-CTRL Screen (Bus-1)

Lock Setting	
Wired Controller Lock	Unlocked ▼
Remote Control Lock	Unlocked ▼
Fan Speed Lock	Unlocked ▼
Cooling mode Lock	Unlocked ▼
Heating mode Lock	Unlocked ▼
Cooling Temp. Lock	Unlocked ▼
Heating Temp. Lock	Unlocked ▼

Fig. 58 —ALL-CTRL Screen (Lock Setting)

NOTE: Some units have different lock modes. For example, wired controllers and gateway products can control swing (lock swing mode), but remote controllers cannot. See Table 18 below.

Table 18 —Available Modes for Indoor Units

System	Mode	Set temperature	Fan speed	Lock
(OA)	Cool, Heat, Fan, Off	Cooling: Celsius 10~30 Fahrenheit 50~86 Heating: Celsius 12~30 Fahrenheit 54~86	High, medium, low	Wired controller lock, remote controller lock, fan speed lock, cooling temperature lower lock, cooling mode lock, heating temperature upper lock, heating mode lock
ERV IO	On, off	\	High, low	Wired controller lock
Other indoor units (HR system)	Cool, Heat, Dry, Fan, Off, Auto	Cooling: Celsius 17~30 Fahrenheit 62~86 Heating: Celsius 12~30 Fahrenheit 54~86	High, medium, low, auto	Wired controller lock, remote controller lock, fan speed lock, cooling temperature lower lock, cooling mode lock, heating temperature upper lock, heating mode lock
Other indoor units (HP system)	Cool, Heat, Dry, Fan, Off	Cooling: Celsius 17~30 Fahrenheit 62~86 Heating: Celsius 12~30 Fahrenheit 54~86	High, medium, low, auto	Wired controller lock, remote controller lock, fan speed lock, cooling temperature lower lock, cooling mode lock, heating temperature upper lock, heating mode lock

Unified command is decided by the highest priority indoor unit in the group.

HP SYSTEM GROUP —

LOGIC: HP ODU with standard IDU (No OA Unit or ERV).

NOTE: AUTO mode is not available.

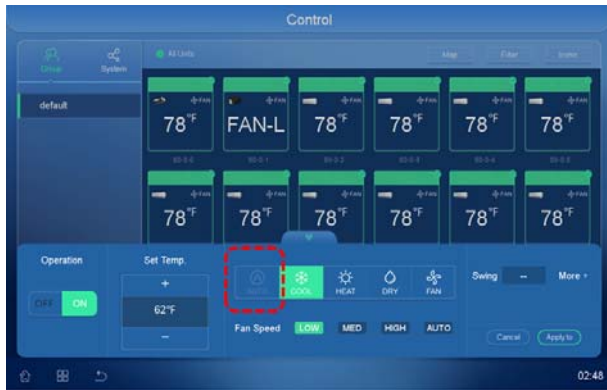

Fig. 59 —HP System Group

OUTSIDE AIR UNIT —

LOGIC: OA with any outdoor unit.

NOTES:

1. AUTO and DRY modes are not available.
2. Different setpoint range.



Fig. 61 —Outside Air Unit

HR SYSTEM GROUP —

LOGIC: HR ODU with standard IDU (No OA Unit or ERV).

NOTE: All modes are available.



Fig. 60 —HR System Group

ERV —

LOGIC: ERV with any outdoor unit.

NOTE: Only FAN mode is available.



Fig. 62 —ERV

ALL-OFF — Send a fast off command to all units in the select area.

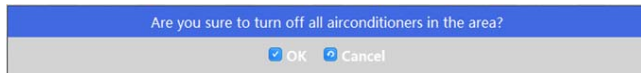

Edit Menu — Click Edit, and the menu bar becomes:



AC+/- — Add or delete indoor units in the selected area

AREA+ — Add area

AREA- — Delete area

RENAME — Rename selected area

DONE — After editing is complete, save settings

User Account Management —  Administrator only.

User ID	User Name	Units List	Operation
1	jack123	2 Units: 0-0, 0-1,	<input type="checkbox"/> + <input type="checkbox"/> - <input type="checkbox"/> ?
2	MAC	2 Units: 3-1, 3-2,	<input type="checkbox"/> + <input type="checkbox"/> - <input type="checkbox"/> ?
3	1	0 Units	<input type="checkbox"/> + <input type="checkbox"/> - <input type="checkbox"/> ?
4	as	0 Units	<input type="checkbox"/> + <input type="checkbox"/> - <input type="checkbox"/> ?
5	5	0 Units	<input type="checkbox"/> + <input type="checkbox"/> - <input type="checkbox"/> ?
6	mac	0 Units	<input type="checkbox"/> + <input type="checkbox"/> - <input type="checkbox"/> ?
7	哈	0 Units	<input type="checkbox"/> + <input type="checkbox"/> - <input type="checkbox"/> ?
8	@12	0 Units	<input type="checkbox"/> + <input type="checkbox"/> - <input type="checkbox"/> ?
9	*99	0 Units	<input type="checkbox"/> + <input type="checkbox"/> - <input type="checkbox"/> ?
10	-q	0 Units	<input type="checkbox"/> + <input type="checkbox"/> - <input type="checkbox"/> ?

Restore Factory Setting Total 38 << 1/4 >> Add Back

Fig. 63 —Account Management

The administrator can manage up to 384 user accounts. Every page can show ten accounts.

ADD — To add a user account:

1. Click the [person] icon
2. Click the [+] Add icon
3. Enter user name.
4. Click OK.

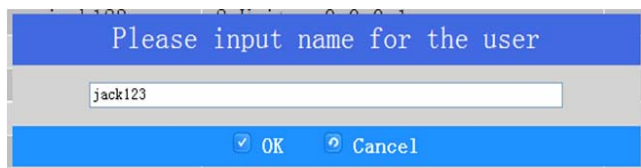

Fig. 64 —Add User

RESTORE FACTORY SETTING — Click “OK” three times to carry out settings.

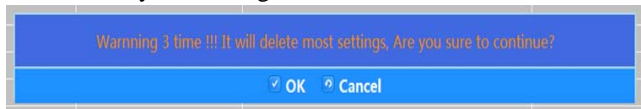

Fig. 65 —Restore Factory Settings

Reset to factory settings deletes all of the user’s operations:

- Deletes all of the user’s accounts
- Resets the Administrator’s password to 123123
- Deletes area settings and equipment names

DISTRIBUTE INDOOR UNITS TO USERS —

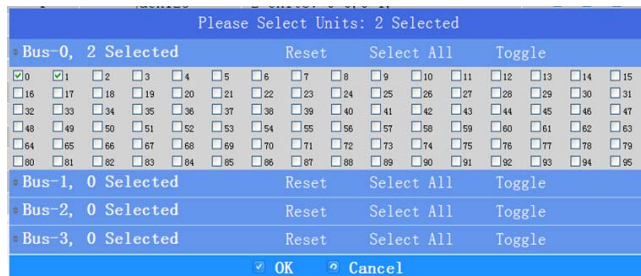

Fig. 66 —Distribute Indoor Units

Select the corresponding indoor address.

- Reset - Remove selected indoor units under this port.
- Select All - Select all indoor units under this port.
- Toggle - Reserve selection.

Only one indoor unit can be distributed into any one group. If the indoor unit has already been distributed, it cannot be selected.

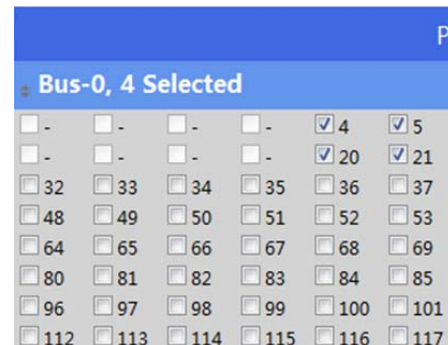

Fig. 67 —Select Indoor Units

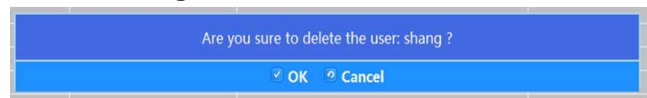

Fig. 68 —Delete This Account

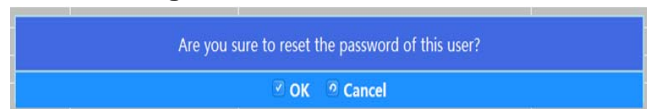

Fig. 69 —Reset This User’s Password

REFRESH — Refreshes the selected equipment status manually.

AREA — Select the corresponding area. For Administrators, Bus 0 through Bus 5 are displayed as default areas. For users, only assigned areas are displayed. If no area is assigned to the user, only their assigned units are displayed under "My Units."

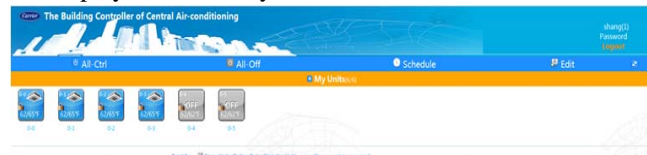



Fig. 70 —Area Selection

The equipment number in the selected area cannot be automatically refreshed. Click  manually refresh.

EQUIPMENT STATUS FIELD — This shows the selected equipments status.

The controller can recognize the different indoor units, which have different symbols as shown below:

Table 19 —Indoor Unit Symbols

Four-way cassette (CASS)	
High wall (HWALL)	
Medium static (MDUCT)	
Low static (LDUCT)	
AHU (VERT)	
High static (HDUCT)	
Compact cassette (SCASS)	
Ceiling floor (UCF)	
Recessed floor (FLRCR)	
Outside air (OA)	
ERV	

The indoor unit's symbol changes when the status of indoor units change as shown below (number in the top left corner).

Table 20 —Change in Indoor Unit Status

Cooling	
Heating	
Dehumidification	
Blow Air	
Auto	
Standby	
Fault	
Lock	
Off-line	

Top Numbers

- First digit: port number (range = 0~3)
- Second digit: indoor unit address (range = 0~95)

Bottom Numbers

- Left number: indoor unit temperature
- Right number: set temperature

If the indoor unit malfunctions, the error code is shown in the middle of the symbol.

The error code does not have any relationship to the temperature. Some of unit's error codes may not be for the unit shown.

If an indoor unit is locked, it will . If the unit has an error at the same time, the lock icon will not display.

Click the indoor unit symbol, and you can control the specific unit. Setting interface includes two parts:

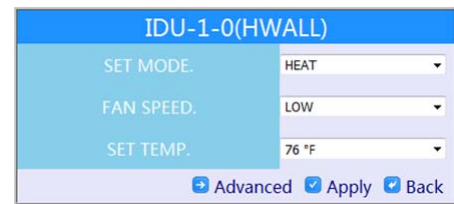

Fig. 71 —Basic Setting - Upper Half

Lock Setting	
Wired Controller Lock	Unlocked
Remote Control Lock	Unlocked
Fan Speed Lock	Unlocked
Cooling Temp. Lock	Unlocked
Cooling mode Lock	Unlocked
Heating Temp. Lock	Unlocked
Heating mode Lock	Unlocked

Fig. 72 —Lock Setting - Lower Half

BASIC INTERFACE SETTING — The controller automatically detects refrigerant system and indoor unit type.

Table 21 —Interface Settings

System	Mode	Set Temperature	Fan Speed
(OA)	Cool, Heat, Fan, Off	Cooling: Celsius (10~30) Fahrenheit (50~86) Heating: Celsius (12~30) Fahrenheit (54~86)	High, Medium, Low
ERV 10	On, Off	N/A	High, Low
Other indoor unit (HR system)	Cool, Heat, Dry, Fan, Off, Auto	Cooling: Celsius (17~30) Fahrenheit (62~86) Heating: Celsius (12~30) Fahrenheit (54~86)	High, Medium, Low, Auto
Other indoor unit (HP system)	Cool, Heat, Dry, Fan, Off	Cooling: Celsius (17~30) Fahrenheit (62~86) Heating: Celsius (12~30) Fahrenheit (54~86)	High, Medium, Low, Auto

If you select auto mode, you need to set the auto cooling and auto heating temperature.

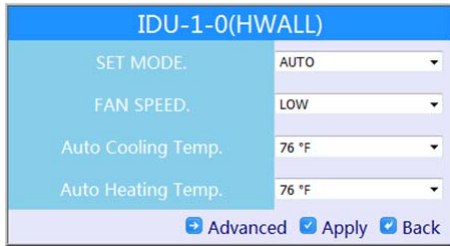

Fig. 72 —Set Auto Cooling and Heating

If AUTO is selected from the Set Mode drop-down menu, the Auto Cooling Temperature must be greater than or equal to the Auto Heating Temperature. Otherwise, an error will occur.

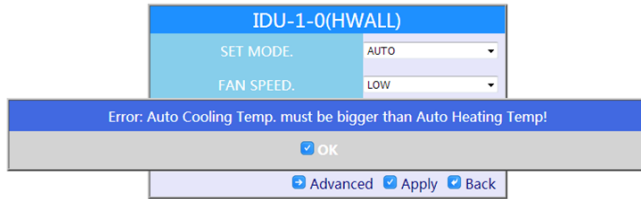

Fig. 73 —Auto Cooling and Heating Error

- If OFF is selected in Set Mode, Set Temp. and Fan Speed cannot be selected.
- If DRY is selected in Set Mode, Fan Speed cannot be selected.
- If FAN is selected in Set Mode, Set Temp. cannot be selected

LOCK SETTING INTERFACE — The Controller will recognize indoor unit automatically:

Table 22 —Lock Setting Interface

Unit Type	Lock Function
ERV (DI/DO) Interface	Wired controller lock
Other indoor units	Wired controller lock, remote controller lock, wind lock, cooling temperature lower limit setting, cooling mode lock, heating temperature upper limit setting, heating mode lock

NOTE: Some units have different lock modes. For example, some units have the lock swing function while remote controllers cannot control swing.

WIRED CONTROLLER LOCK — (Wired Controller Lock) Read parameter: Locked, Unlocked, 0---Unlocked, 1---Locked

If other values are input, the system will report an error.

REMOTE CONTROL LOCK — (Wired Controller Lock) Read parameter: Locked, Unlocked, 0---Unlocked, 1---Locked

If other values are input, the system will report an error.

FAN SPEED LOCK — (Wind Speed Lock) Read parameter: Unlocked, Low, Medium, High, 0---Unlocked, 1---Low, 2---Medium, 3---High

If other values are input, the system will report an error.

COOLING TEMP. LOCK — (Cooling temperature lower limit lock) Read parameter: Unlocked, 0---Unlocked

Range: Celsius = 17~30, Fahrenheit = 62~86.

If other values are input, the system will report an error.

COOLING MODE LOCK — Read parameter: Locked, Unlocked, 0---Unlocked, 1---Cooling Lock, 2---Heating Lock

If other values are input, the system will report an error.

HEATING TEMP. LOCK — (Heating temperature upper limit lock) Read parameter: Unlocked, 0---Unlocked

Range: Celsius = 12~30, Fahrenheit = 54~86

If other values are input, the system will report an error.

HEATING MODE LOCK — (Heating mode lock) Read parameter: Locked, Unlocked, 0---Unlocked, 1---Cooling Lock, 2---Heating Lock

If other values are input, the system will report an error.

Click [Advanced] for more equipment information.

IDU-1-0(OA)		Refrigerant System	Refresh	Back
Run Mode	Cool	Setting Temp.	65°F	
Fan Speed	Low	Reserved	-	
Fan Suction Temp.	77°F	Outlet Temp.	100°F	
Malfunction	-	Reserved	-	

Fig. 74 —Outside Air Unit

IDU-1-64(ERV IO)		Refrigerant System	Refresh	Back
Run Mode	Fan	IDU type	11	
Room Temp.	77°F	Fan Speed	Low	
Malfunction	-	-	-	

Fig. 75 —ERV

IDU-1-64(HWALL)		Refrigerant System	Refresh	Back
Run Mode	Cool	Setting Temp./Dual Point(Cooling)	70°F	
Fan Speed	Auto/Low	Dual Point(Heating)	70°F	
Room Temp.	77°F	IDU type	1	
Malfunction	-	Reserved	-	

Fig. 76 —Other Indoor Unit

Click refresh to refresh the interface.

RUN MODE — Auto, Cooling, Heating, Dry, Fan, OFF

FAN SPEED — Auto, Low, Medium, High

ROOM TEMP. — Indoor unit (If it is an outside air unit, it will show Fan Suction Temp)

Table 23 —Indoor Unit Type

Value	Indoor unit type
0	CASS---Four way cassette
1	HWALL---High wall
2	MDUCT---Medium static
3	LDUCT---Low static
4	VERT---AHU
5	HDUCT---High static
6	SCASS---Compact cassette
7	VCF---Ceiling and floor
8	FLRCR---Recessed floor
9	OA---Outside air
10	ERV

SETTING TEMP. / DUAL POINT (COOLING) — Set the temperature under non-auto mode. Under auto mode, set cooling temperature.

DUAL POINT (HEATING) — In non-auto mode (Dry, Heating, Cooling, Fan), this function is invalid.

MALFUNCTION — An error code will show if there is error.

Click Refrigerant System to check unit's corresponding running conditions.

System 0# on bus-1				Refresh	Back
Run mode	Off	ODU Type	1		
Reserved	-	Qty. of IDU	64		
Display Temp. Unit	°F	ODU Online	0#,1#,2#,3#		
System Status	0# ODU OFF	FAN OFF	Malfunction of ODU 0#	--	
	1# ODU OFF	FAN OFF	Malfunction of ODU 1#	--	
	2# ODU OFF	FAN OFF	Malfunction of ODU 2#	--	
	3# ODU OFF	FAN OFF	Malfunction of ODU 3#	--	

Fig. 77 —Unit's Running Condition

Click Refresh to manually refresh the current interface information.

RUN MODE — Off, Fan, Cool, Heat, Force Cool, Master Cool, Master Heat, Force Heat

DISPLAY TEMP. UNIT — Celsius, Fahrenheit

System Status —

0# ODU —

ON---0 main unit on, OFF---0 main unit off, FAN ON---0 main unit fan on, FAN OFF---0 main unit fan off

1# ODU —

ON---1 sub unit on, OFF---1 sub unit off, FAN ON---1 sub unit fan on, FAN OFF---1 sub unit fan off

2# ODU —

ON---2 sub unit on, OFF---2 sub unit off, FAN ON---2 sub unit fan on, FAN OFF---2 sub unit fan off

3# ODU —

ON---3 sub unit on, OFF---3 sub unit off, FAN ON---3 sub unit fan on, FAN OFF---3 sub unit fan off

ODU TYPE —

Table 24 —Outdoor Unit Type

Number	Model
1	Carrier HR
2	Carrier HP
8	Carrier Mini-VRF

QTY. OF IDU — Number of indoor units

ODU ONLINE — Number of online outdoor unit

MALFUNCTION OF ODU 0# —

An error code will show if there is an error.

-- will show if there are no errors.

MALFUNCTION OF ODU 1# —

An error code will show if there is an error.

-- will show if there are no errors.

MALFUNCTION OF ODU 2# —

An error code will show if there is an error.

-- will show if there are no errors.

MALFUNCTION OF ODU 3# —





An error code will show if there is an error.

-- will show if there are no errors.

Click Refresh to manually refresh the unit.

Click Back to go back to the last interface.

Table 25 —Outdoor Unit Symbol

Heat pump	
Heat recovery	
Mini VRF	
Off-line	

Click the outdoor unit symbol to check the outdoor unit status.

ODU-1-96		Refrigerant System Refresh Back	
Ambient Temp.	77°F	On/Off	Turned off
Condenser Temp.	77°F	Compressor Turned On	0
Reserved	-	Reserved	-

Fig. 78 —Outdoor Unit Status

Click Refresh to manually refresh the current interface.

AMBIENT TEMP. — Outdoor unit outdoor ambient temperature

CONDENSER TEMP. — Condenser temperature

ON/OFF — Turn system on or off

COMPRESSOR TURNED ON — Number of compressors that are on

By clicking the symbols on the bottom of the interface, you can select all of the outdoor units or just show the online outdoor units. You can also count the number of outdoor units in this area or port (number of online outdoor units and number of offline outdoor units).



Click the number under the symbol to change the unit name.



Fig. 79 —Change Unit Name

After changing the units' name, restart the system. The user's unit's name will be updated in the Web Interface.