

40QQ Series
Variable Refrigerant Flow (VRF) Rooftop
Heat Recovery and Heat Pump
Sizes 036, 048, 060
3 - 5 Nominal Ton



Engineering Data Book



Manufacturer reserves the right to discontinue, or change at any time, specifications or designs without notice and without incurring obligations.

TABLE OF CONTENTS

	PAGE		PAGE
40QQ BASIC INFORMATION	3	PIPING RULES	13
SPECIFICATIONS	4	WIRING DIAGRAMS	14
PHYSICAL DATA	5	ELECTRICAL DATA	16
DIMENSIONS	7	FAN PERFORMANCE	16
CENTER OF GRAVITY	9	SOUND PERFORMANCE	21
RECOMMENDED SERVICE CLEARANCE	10	APPLICATION DATA	21
CURB DIMENSIONS	11	ECONOMIZER, BAROMETRIC RELIEF, AND PE PERFORMANCE	22
PIPING DIAGRAM	12	CAPACITY TABLES	23

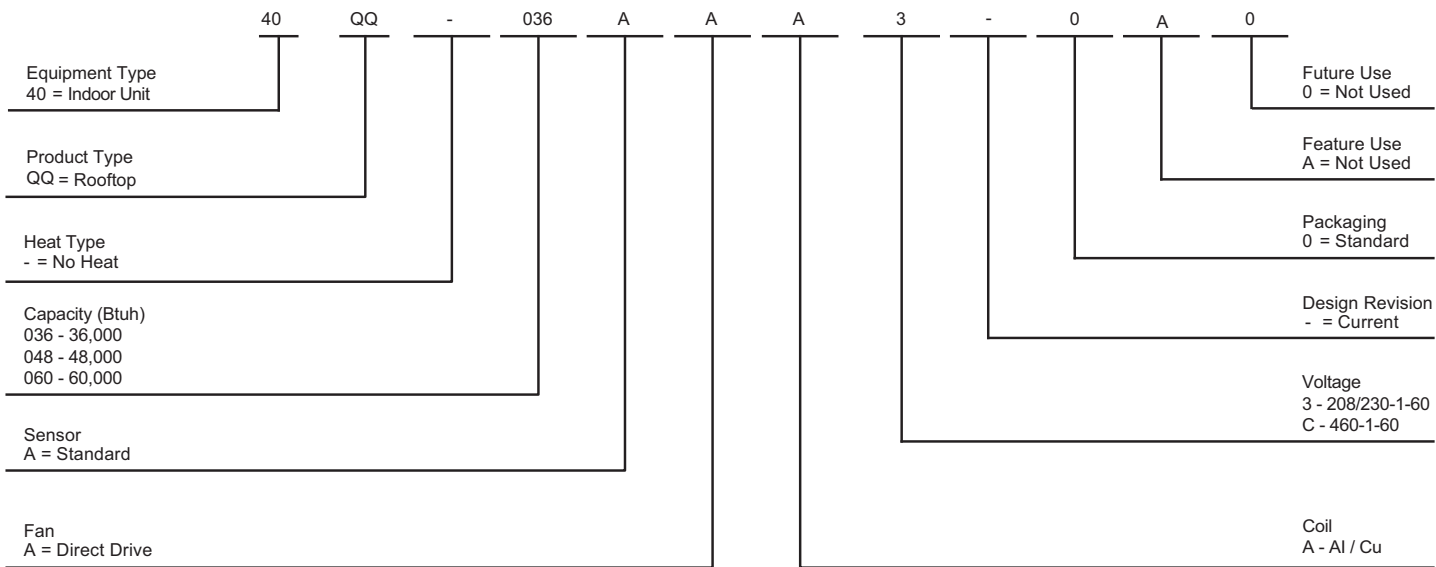

Fig. 1 - Nomenclature

40QQ BASIC INFORMATION

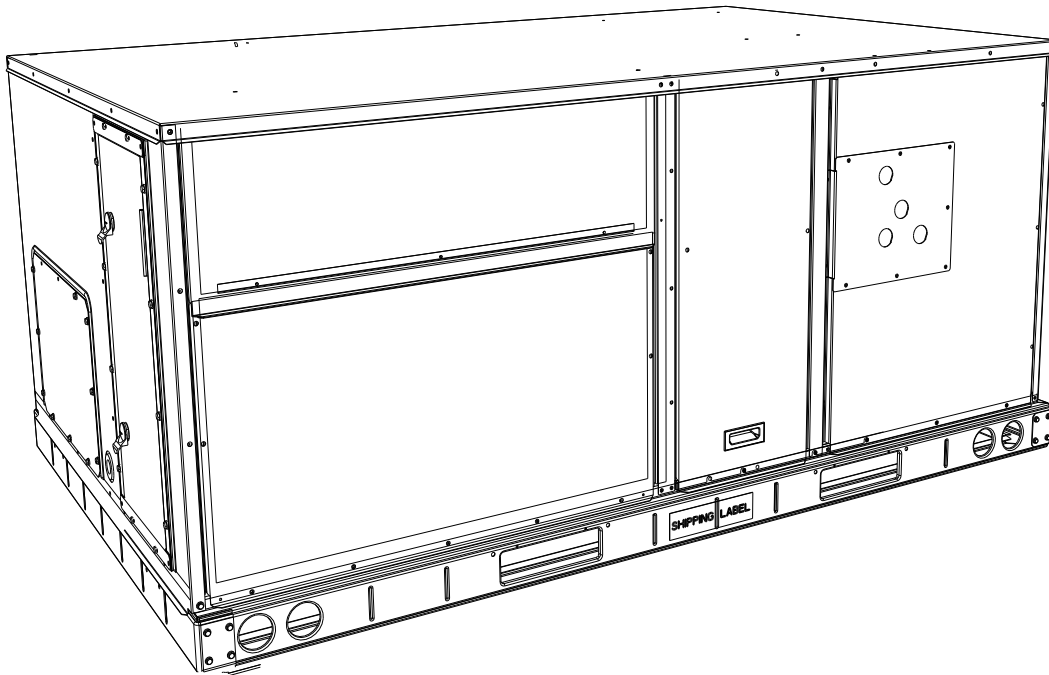

Fig. 2 - 40QQ Rooftop Unit

UNIT FEATURES

- Direct drive (multi speed/torque) ECM motor.
- Exclusive non-corrosive composite condensate pan in accordance with ASHRAE 62 Standard, sloping design; side or center drain.
- Single point electrical connection.
- Pre-painted exterior panels and primer-coated interior panels tested to 500 hours salt spray protection.
- Fully insulated cabinet with foil faced insulation throughout the entire cabinet.
- Access panels with easy grip handles.
- Innovative, easy starting, no-strip screw feature on unit access panels.
- Two-inch disposable return air filters.
- Tool-less filter access door.
- Field Convertible airflow. Convert a unit from vertical to horizontal airflow to easily overcome job site complications.
- Full perimeter base rail with built-in rigging adapters and fork truck slots.
- Permanently lubricated evaporator-fan motor.
- Mounting brackets for flow selector box.
- Standard Limited Warranty: Toshiba Carrier VRF standard warranty.



SPECIFICATIONS

Table 1 – Data Table (208/230-1-60)

Model		40QQ- 036AAA3- 0A0	40QQ- 048AAA3- 0A0	40QQ- 060AAA3- 0A0
Power Supply	V/Ph/Hz	208/230- 1- 60		
Cooling Capacity	Btu/h	36,000	48,000	60,000
Heating Capacity	Btu/h	38,000	52,000	66,000
Rated Airflow	Cooling	CFM	1050	1750
	Heating	CFM	1050	1750
Sound Data (H, M, L)	dBA	74/71/62	75/70/60	75/70/61
Electrical Supply	MCA	A	7.25	9.25
	MOCP	A	15.0	15.0
	FLA	A	6.7	8.5
Filter		2 inch (51 mm) standard		
Dimensions (H x W x D)	in	33- 3/8 x 74- 3/8 x 46- 5/8	41- 3/8 x 74- 3/8 x 46- 5/8	41- 3/8 x 74- 3/8 x 46- 5/8
Net Weight	lbs	364.0	385.0	394.0
Shipping Weight	lbs	417.0	439.0	447.0
External Static Pressure (Factory setting)	WG	0.15	0.20	0.20
External Static Pressure (Max)	WG	1.65	1.38	1.15
Piping Connections	Gas side	in	5/8	5/8
	Liquid side	in	3/8	3/8
	Drain port	in	3/4	3/4
Refrigerant Control		Pulse Motor Valve (PMV)		
Connectable Outdoor Unit		Heat Pump (SMMS- e) Heat Recovery (SHRM- e)		

Table 2 – Data Table (460-1-60)

Model		40QQ- 036AAAC- 0A0	40QQ- 048AAAC- 0A0	40QQ- 060AAAC- 0A0
Power Supply	V/Ph/Hz	460- 1- 60		
Cooling Capacity	Btu/h	36,000	48,000	60,000
Heating Capacity	Btu/h	38,000	54,000	66,000
Rated Airflow	Cooling	CFM	1050	1750
	Heating	CFM	1050	1750
Sound Data (H, M, L)	dBA	74/71/62	75/70/60	75/70/61
Electrical Supply	MCA	A	4.0	5.0
	MOCP	A	15.0	15.0
	FLA	A	3.7	4.6
Filter		2 inch (51 mm) standard		
Dimensions (H x W x D)	in	33- 3/8 x 74- 3/8 x 46- 5/8	41- 3/8 x 74- 3/8 x 46- 5/8	41- 3/8 x 74- 3/8 x 46- 5/8
Net Weight	lbs	364.0	385.0	394.0
Shipping Weight	lbs	417.0	439.0	447
External Static Pressure (Factory setting)	WG	0.15	0.20	0.20
External Static Pressure (Max)	WG	1.65	1.38	1.15
Piping Connections	Gas side	in	5/8	5/8
	Liquid side	in	3/8	3/8
	Drain port	in	3/4	3/4
Refrigerant Control		Pulse Motor Valve (PMV)		
Connectable Outdoor Unit		Heat Pump (SMMS- e) Heat Recovery (SHRM- e)		

PHYSICAL DATA

Table 3 – Physical Data

Refrigeration System	Metering device	40QQ*036	40QQ*048	40QQ*060	
	High- press. Trip / Reset (psig)	PMV 630 / 505	PMV 630/505	PMV 630 / 505	
	Low- press. Trip / Reset (psig)	27 / 44	27/44	27 / 44	
Heat Pump Coil	Material	Cu / Al	Cu / Al	Cu / Al	
	Coil type	3/8- in RTPF	3/8- in RTPF	3/8- in RTPF	
	Rows / FPI	3 / 15	3 / 15	4 / 15	
	Total Face Area (ft ²)	5.5	7.3	7.3	
	Condensate Drain Connection Size	3/4- in	3/4- in	3/4- in	
Evaporator fan and motor	Standard Static	Motor Qty / Drive type	1 / Direct ECM	1 / Direct ECM	1 / Direct ECM
		Max BHP	1	1	1
		RPM range	600- 1200	600- 1200	600- 1200
		Motor Frame Size	48	48	48
		Fan Qty / Type	1 / Centrifugal	1 / Centrifugal	1 / Centrifugal
		Fan Diameter (in)	10 x 10	10 x 10	11 x 10
Filters	RA Filter # / size (in)	2 / 16 x 25 x 2	4 / 16 x 16 x 2	4 / 16 x 16 x 2	
	OA inlet screen # / size (in)	1 / 20 x 24 x 1	1 / 20 x 24 x 1	1 / 20 x 24 x 1	

Factory-Supplied and Field-Installed Accessories

Economizer

Economizers save energy, money, and improve comfort levels in the conditioned space. They bring in fresh outside air for ventilation, and provide cool outside air to cool your building. This also is the preferred method of low ambient cooling.

Table 4 – Economizer

ALL SIZES	Type	PART NUMBER
	Horizontal	CRECOMZR077A00
	Vertical	CRECOMZR076A00

Electric Heaters

Carrier offers a full line of field-installed accessory heaters. The heaters are very easy to use and install. They are all pre-engineered and certified.

Table 5 – Electric Heater (Field-Installed Only) (208/230-3-60)

Tonnage	Part Number	E- Heater	Single Pt Kit Part #	Nominal	Application	Nominal
		(Phase)		(kW)	(kW)	(kBtu)
3 Ton	CRHEATER101A00	3	CRSINGLE037A00	4.4	3.3/4.0	15.01
	CRHEATER102A00	3	CRSINGLE037A00	6.5	4.9/6.0	22.18
	CRHEATER103B00	3	CRSINGLE037A00	8.7	6.5/8.0	29.68
	CRHEATER104B00	3	CRSINGLE037A00	10.5	7.9/9.6	35.83
4 Ton	CRHEATER102A00	3	CRSINGLE037A00	6.5	4.9/6.0	22.18
	CRHEATER103B00	3	CRSINGLE037A00	8.7	6.5/8.0	29.68
	CRHEATER105A00	3	CRSINGLE037A00	16	12.0/14.7	54.59
5 Ton	CRHEATER102A00	3	CRSINGLE037A00	6.5	4.9/6.0	22.18
	CRHEATER104B00	3	CRSINGLE037A00	10.5	7.9/9.6	35.83
	CRHEATER105A00	3	CRSINGLE037A00	16	12.0/14.7	54.59
	CRHEATER104B00,104B00	3	CRSINGLE038A00	21	15.8/19.3	71.65

Table 6 – Electric Heater (Field-Installed Only) (460-3-60)

Tonnage	Part Number	E- Heater	Single Pt Kit Part #	Nominal	Application	Nominal
		(Phase)		(kW)	(kW)	(kBtu)
3 Ton	CRHEATER106A00	3	CRSINGLE037A00	6	5.5	20.47
	CRHEATER107A00	3	CRSINGLE037A00	8.8	8.1	30.03
	CRHEATER108A00	3	CRSINGLE037A00	11.5	10.6	39.24

4 Ton	CRHEATER106A00	3	CRSINGLE037A00	6	5.5	20.47
	CRHEATER108A00	3	CRSINGLE037A00	11.5	10.6	39.24
	CRHEATER109A00	3	CRSINGLE037A00	14	12.9	47.77

5 Ton	CRHEATER106A00	3	CRSINGLE037A00	6	5.5	20.47
	CRHEATER108A00	3	CRSINGLE037A00	11.5	10.6	39.24
	CRHEATER109A00	3	CRSINGLE037A00	14	12.9	47.77
	CRHEATER108A00,108A00	3	CRSINGLE037A00	23	21.1	78.48

Table 7 – Optional Accessory Weights

40QQ*	UNITS Lb (kg)		
	036	048	060
Base Unit	364 (165)	385 (175)	394 (179)
Economizer			
Vertical	50 (23)	50 (23)	50 (23)
Horizontal	80 (36)	80 (36)	80 (36)
Curb			
14- in/356 mm	115 (52)	115 (52)	115 (52)
24- in/610 mm	197 (89)	197 (89)	197 (89)

DIMENSIONS

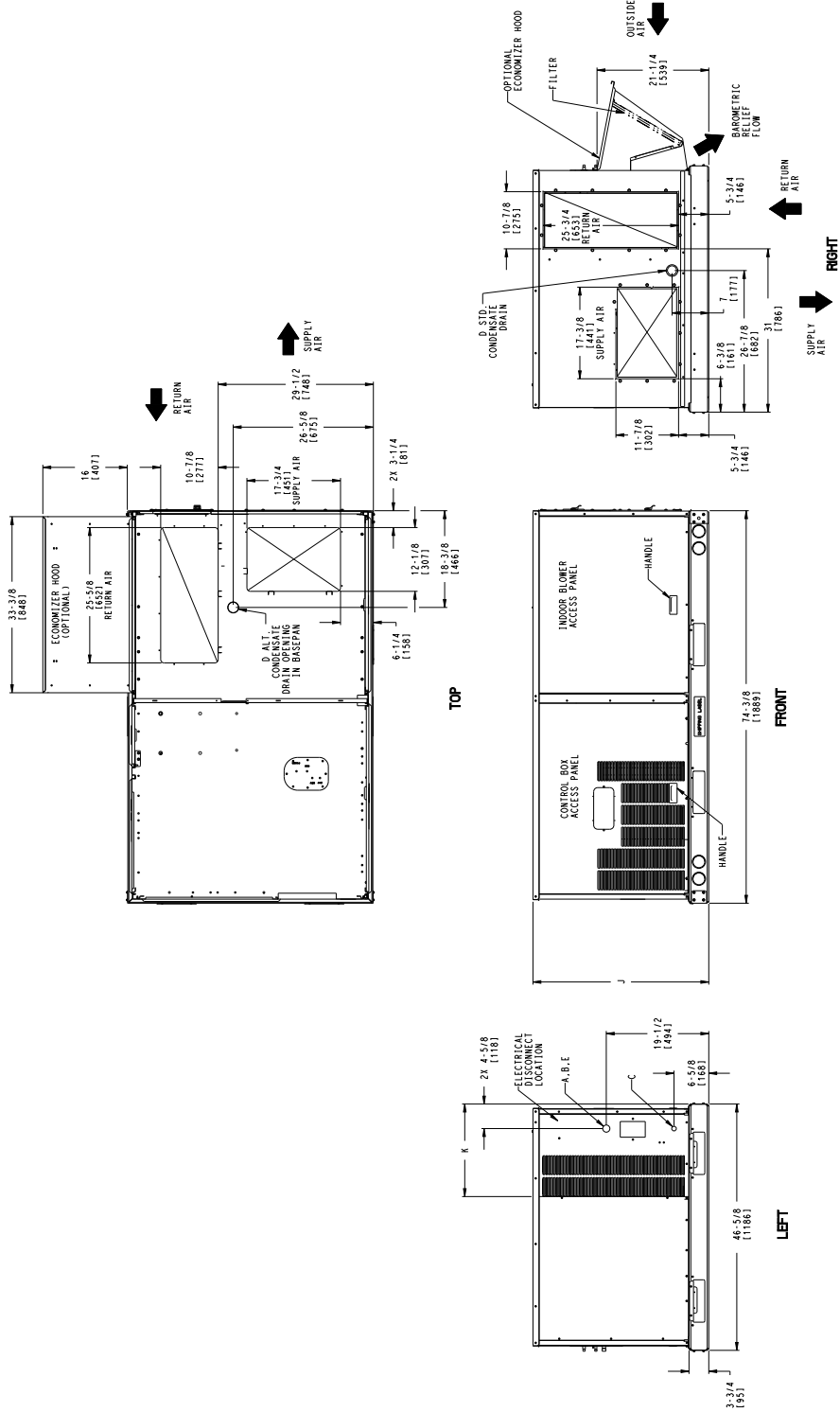

Fig. 3 - Dimensional Drawing

Table 8 – Unit Sizes

UNIT	J	K
40QQ- 036	33- 3/8 [847]	17- 1/2 [445]
40QQ- 048	41- 3/8 [1051]	13- 5/8 [346]
40QQ- 060	41- 3/8 [1051]	13- 5/8 [346]

Table 9 – Connection Sizes

A	1- 3/8" [35] DIA Field Power Supply Hole
B	2" [50] DIA Power Supply Knockout
C	7/8" [22] DIA Field Control Wiring Hole
D	3/4" - NPT Condensate Drain
E	2- 1/2" [64] DIA Power Supply Knockout

NOTE: All dimensions are in inches. Dimensions in [] are in millimeters.

DIMENSIONS (CONT.)

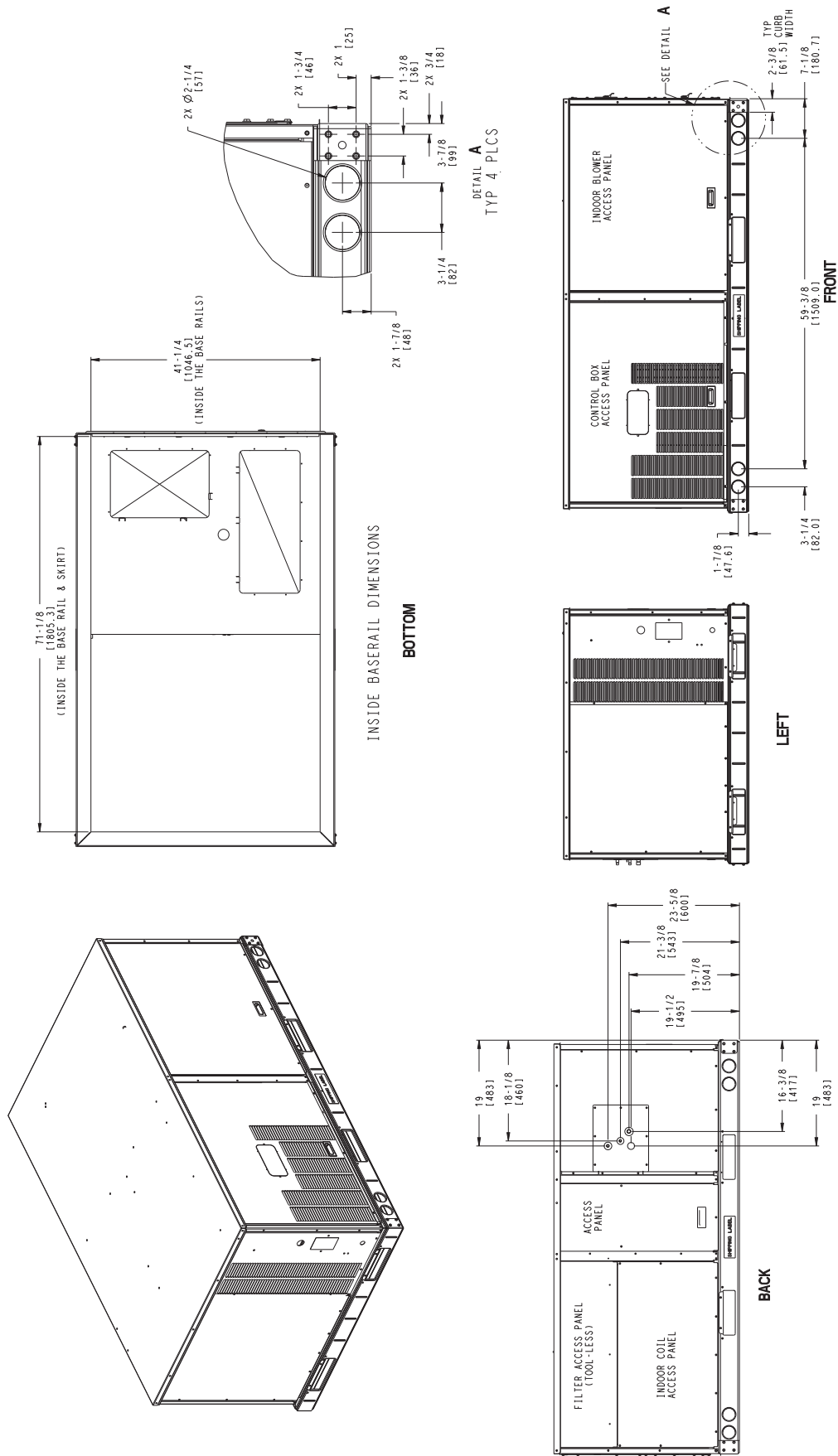

Fig. 4 - Dimensional Drawing

NOTE: All dimensions are in inches. Dimensions in [] are in millimeters.

CENTER OF GRAVITY

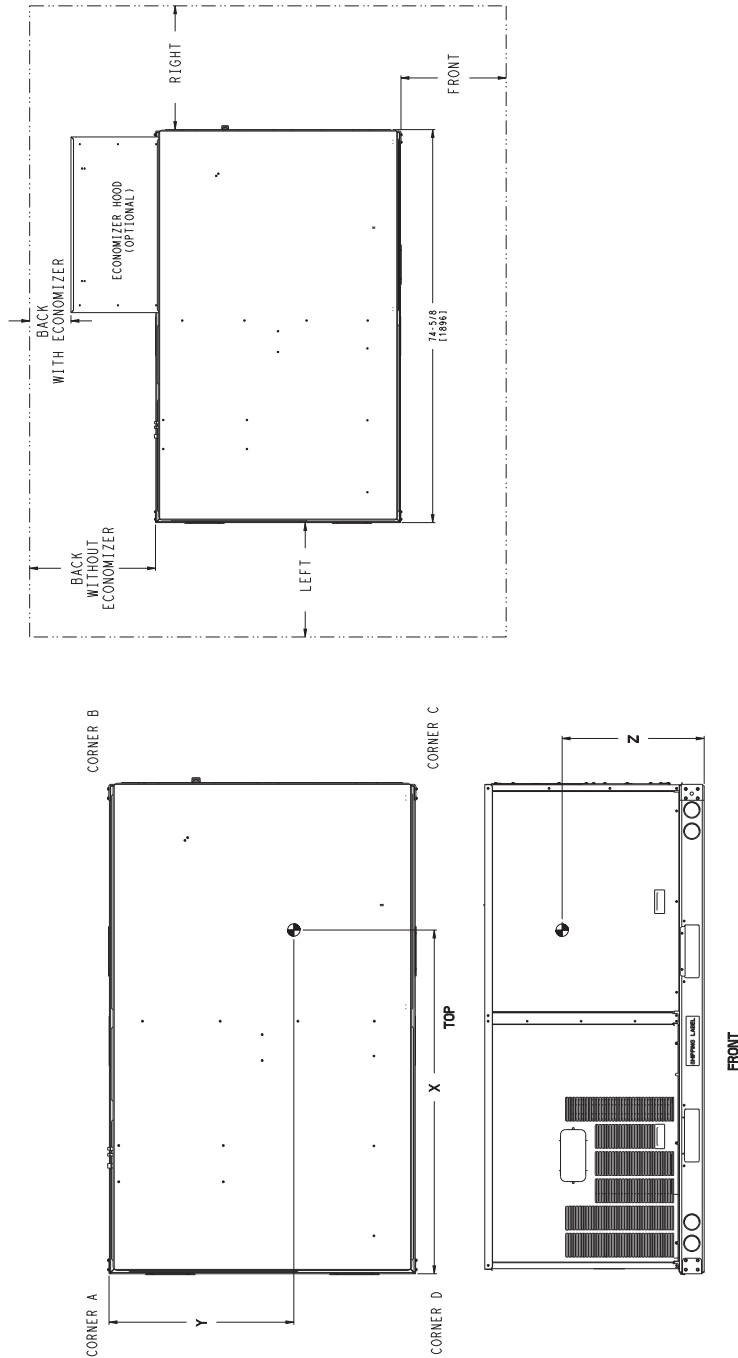

Fig. 5 - Center of Gravity

Unit	Std. Unit Weight		Corner Weight (A)		Corner Weight (B)		Corner Weight (C)		Corner Weight (D)		Center of Gravity		Height
	Lbs	Kg	Lbs	Kg	Lbs	Kg	Lbs	Kg	Lbs	Kg	X	Y	Z
40QQ- 036	364	165	86	39	87	39	96	44	95	43	39- 1/2 [1003]	27- 7/8 [708]	17- 3/8 [441]
40QQ- 048	385	175	91	41	92	42	102	46	101	46	39- 1/2 [1003]	23- 3/8 [594]	17- 1/8 [435]
40QQ- 060	394	179	93	42	94	43	104	47	103	47	39- 1/2 [1003]	23- 3/8 [594]	17- 1/8 [435]

NOTE:

1. Standard unit weight is without electric heat and without packaging.
2. For other options and accessories, refer to the page 6.
3. All dimensions are in inches. Dimensions in [] are in millimeters.

RECOMMENDED SERVICE CLEARANCE

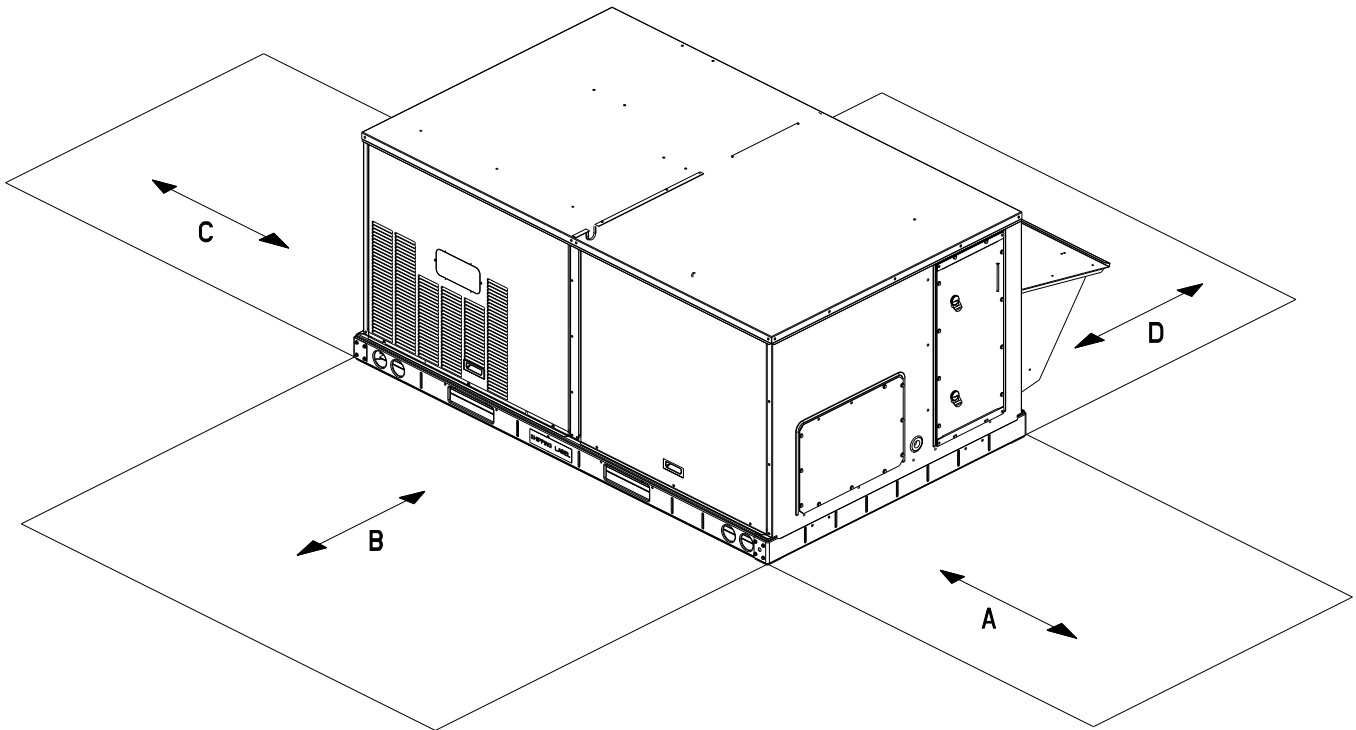

Fig. 6 - Service Clearance Dimensional Drawing

Location	Dimension	Condition
A	48 in (1219 mm) 18 in (457 mm) 18 in (457 mm) 12 in (305 mm)	Unit disconnect is mounted on panel. No disconnect, convenience outlet option. Recommended service clearance. Minimum clearance.
B	42 in (1067 mm) 36 in (914 mm) Special	Surface behind servicer is grounded (e.g., metal, masonry wall). Surface behind servicer is electrically non- conductive (e.g., wood, fiberglass). Check sources of flue products within 10 ft of unit fresh air intake hood.
C	36 in (914 mm) 18 in (457 mm)	Side condensate drain is used. Minimum clearance.
D	42 in (1067 mm) 36 in (914 mm)	Surface behind servicer is grounded (e.g., metal, masonry wall, another unit). Surface behind servicer is electrically non- conductive (e.g., wood, fiberglass).

NOTE: Unit is not designed to have overhead obstruction. Contact Application Engineering for guidance on any application planning overhead obstruction or for vertical clearances.

CURB DIMENSIONS

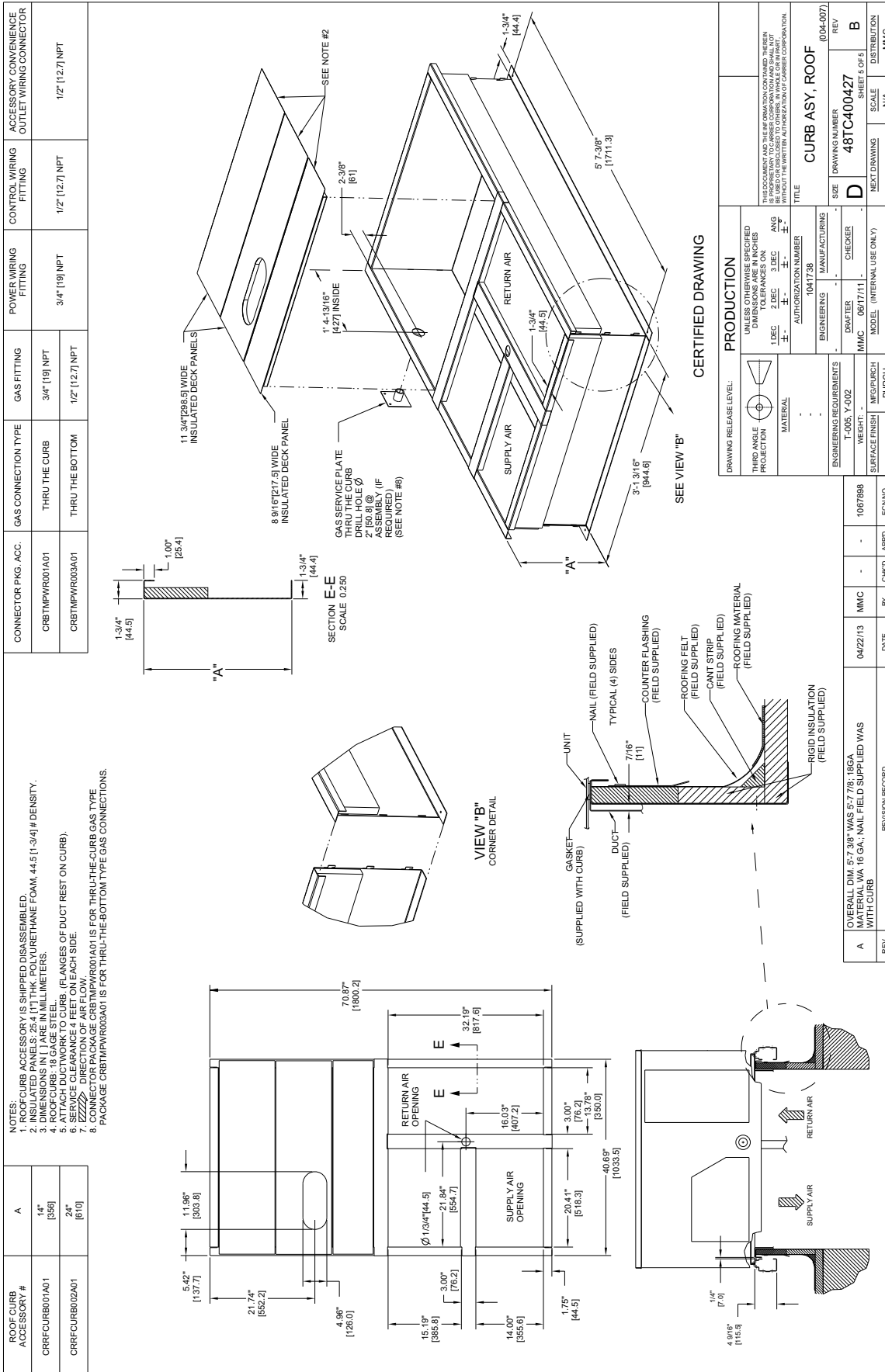

Fig. 7 - Roof Curb Details

PIPING DIAGRAM

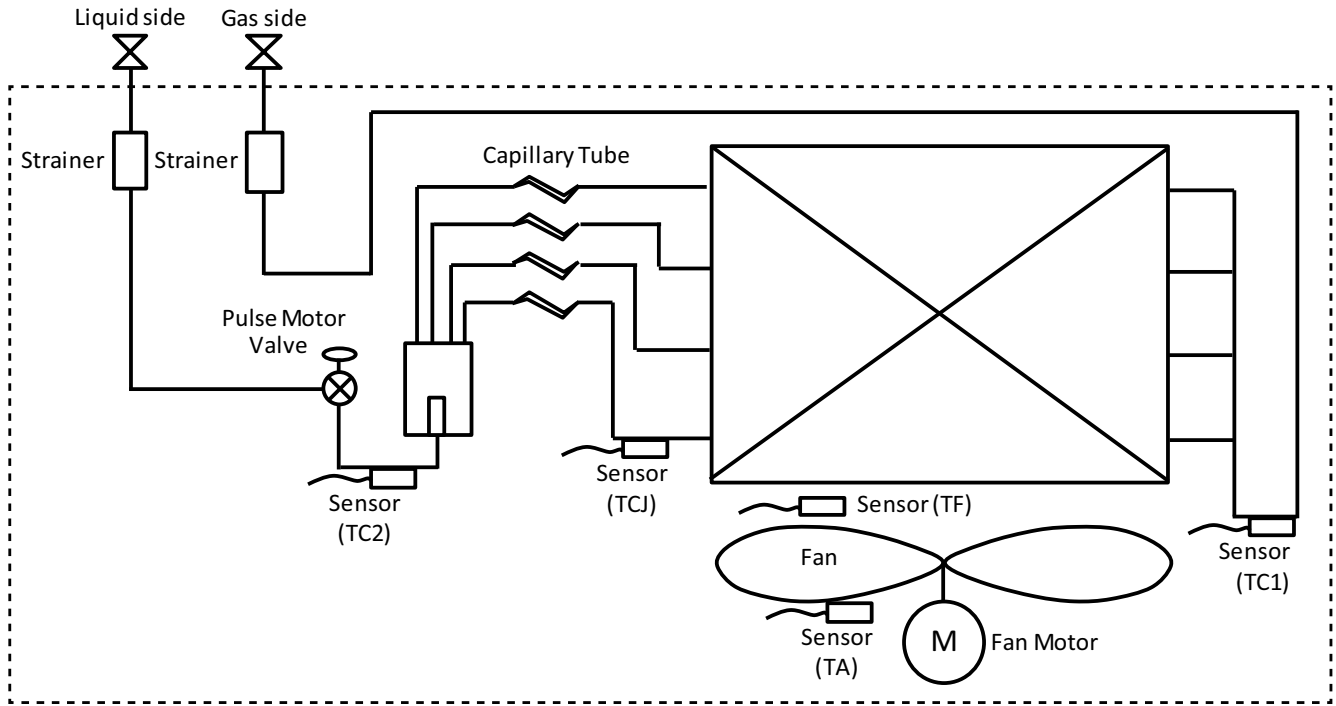

Fig. 8 - Piping

Table 10 – Functional Parts in Indoor Unit

Functional Part Name		Functional Outline
Pulse Motor Valve	PMV	(Connector CN082 (6P) : Blue)
		<ul style="list-style-type: none"> • Controls superheat in cooling operation • Controls subcooling in heating operation • Recovers refrigerant oil in cooling operation • Recovers refrigerant oil in heating operation
Temperature Sensor	TA	(Connector CN104 (3P) : Yellow)
	TF	(Connector CN103 (3P) : Green)
	TC1	(Connector CN100 (3P) : Brown)
	TC2	(Connector CN101 (2P) : Black)
	TCJ	(Connector CN102 (2P) : Red)

PIPING RULES

System Restrictions

Table 11 – With MMY-MAP__6(HT6P , HT9P , FT6P , FT9P , FT2P)- UL

Connected 40QQ Models	Max. Connected Capacity (*1)	
	H2 ≤ 49 ft (15 m)	H2 > 49 ft (15 m)
40QQ-036	135% of outdoor unit's capacity	105% of outdoor unit's capacity
40QQ-048	135% of outdoor unit's capacity	105% of outdoor unit's capacity
40QQ-060	100% of outdoor unit's capacity (*2)	100% of outdoor unit's capacity (*2)

*1 H2 is the maximum height difference between the indoor units.

*2 If any 40QQ-60 (60kBtu, 5 ton) is connected to the system, maximum connected capacity is 100%.

Table 12 – With MCY-MAP_7H5- UL

1:1 Combination

Only allowed at 100% connected capacity.

Outdoor unit	Allowed Indoor Unit
MCY- MAP0367HS- UL	With 40QQ036
MCY- MAP0487HS- UL	With 40QQ048
MCY- MAP0607HS- UL	With 40QQ060

Table 13 – Multiple 40QQ + MCY

This is the only allowed such combination.

Outdoor Unit	Allowed Indoor Unit
MCY- MAP0607HS- UL	With 40QQ036 + 40QQ036

WIRING DIAGRAMS

FAN TAP TABLE

UNIT	1	2	3	4	5
036	BRN	YEL			BLU
048	BRN		YEL		BLU
060	BRN	YEL			BLU

NOTES:

- IF ANY OF THE ORIGINAL WIRE FURNISHED MUST BE REPLACED, IT MUST BE REPLACED WITH TYPE 90 C WIRE OR ITS EQUIVALENT.
- 203/230V UNIT TRAIL IS WIRED FOR 300V UNIT. IF UNIT IS TO BE RUN WITH 208V POWER SUPPLY DISCONNECT BLK WIRE FROM 230V TAP AND CONNECT TO 200V TAP.
- USE COPPER CONDUCTOR ONLY.
- REMOVE JUMPER FOR ECONOMIZER.
- SEE TABLE FOR FAN TAPS BASED ON TONNAGE.
- ECONOMIZER HARNESS SHIPPED LOOSE IN BAG IN CONTROL BOX.

- (LEGEND)
- DISC DISCONNECT SWITCH
 - HTR ELECTRIC HEAT STRIP
 - LS LIMIT SWITCH
 - TRN TRANSFORMER
 - FACTORY WIRING
 - FIELD WIRING
 - HEATER CONTACTOR
 - OPTION WIRING

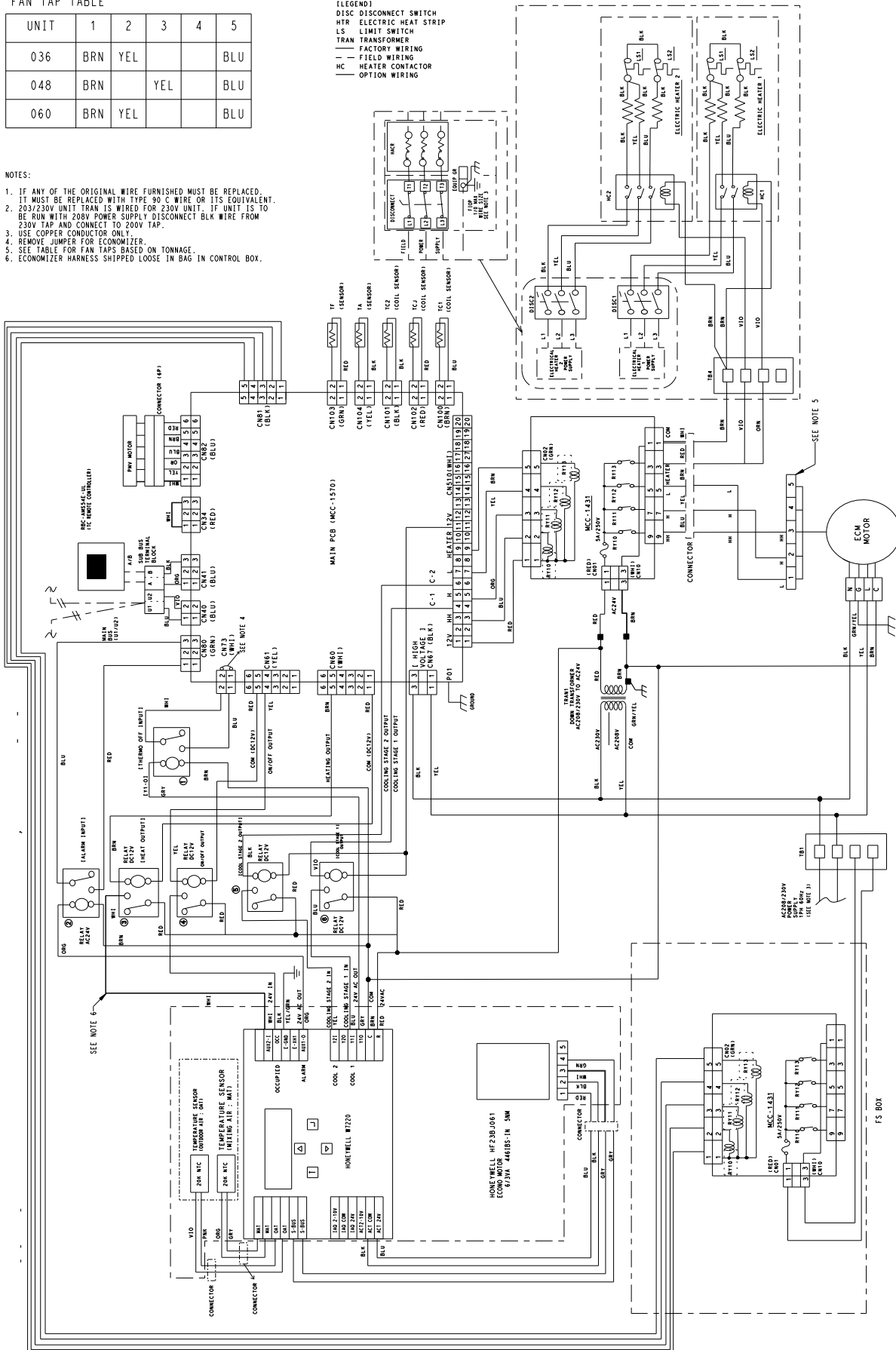

Fig. 9 - 40QQ Power Wiring Diagram, 208/230V, 60Hz

WIRING DIAGRAMS (CONT.)

FAN TAP TABLE

UNIT	1	2	3	4	5
3T	BRN	YEL			BLU
4T	BRN		YEL		BLU
5T	BRN	YEL			BLU

LEGEND:
 DISC DISCONNECT SWITCH
 HTR ELECTRIC HEAT STRIP
 LS LIMIT SWITCH
 TRAN TRANSFORMER
 FCT FACTORY WIRING
 FLD FIELD WIRING
 HC HEATER CONTACTOR
 OPT OPTION WIRING

NOTES:

1. IF ANY OF THE ORIGINAL WIRE FURNISHED MUST BE REPLACED IT MUST BE REPLACED WITH THE TYPE AND SIZE OF WIRE OR ITS EQUIVALENT.
2. 208/230V UNIT TRAN IS WIRED FOR 230V UNIT. IF UNIT IS TO BE RUN WITH 208V POWER SUPPLY DISCONNECT BLK WIRE FROM 230V TAP AND CONNECT TO 208V TAP.
3. USE COPPER CONDUCTOR ONLY.
4. REMOVE JUMPER FOR ECONOMIZER.
5. SEE TABLE FOR FAN TAP POS BASED ON TONNAGE.
6. ECONOMIZER HARNESS SHIPPED LOOSE IN BAG IN CONTROL BOX.
7. PIGTAIL SUPPLIED LOOSE IN BAG IN CONTROL BOX.

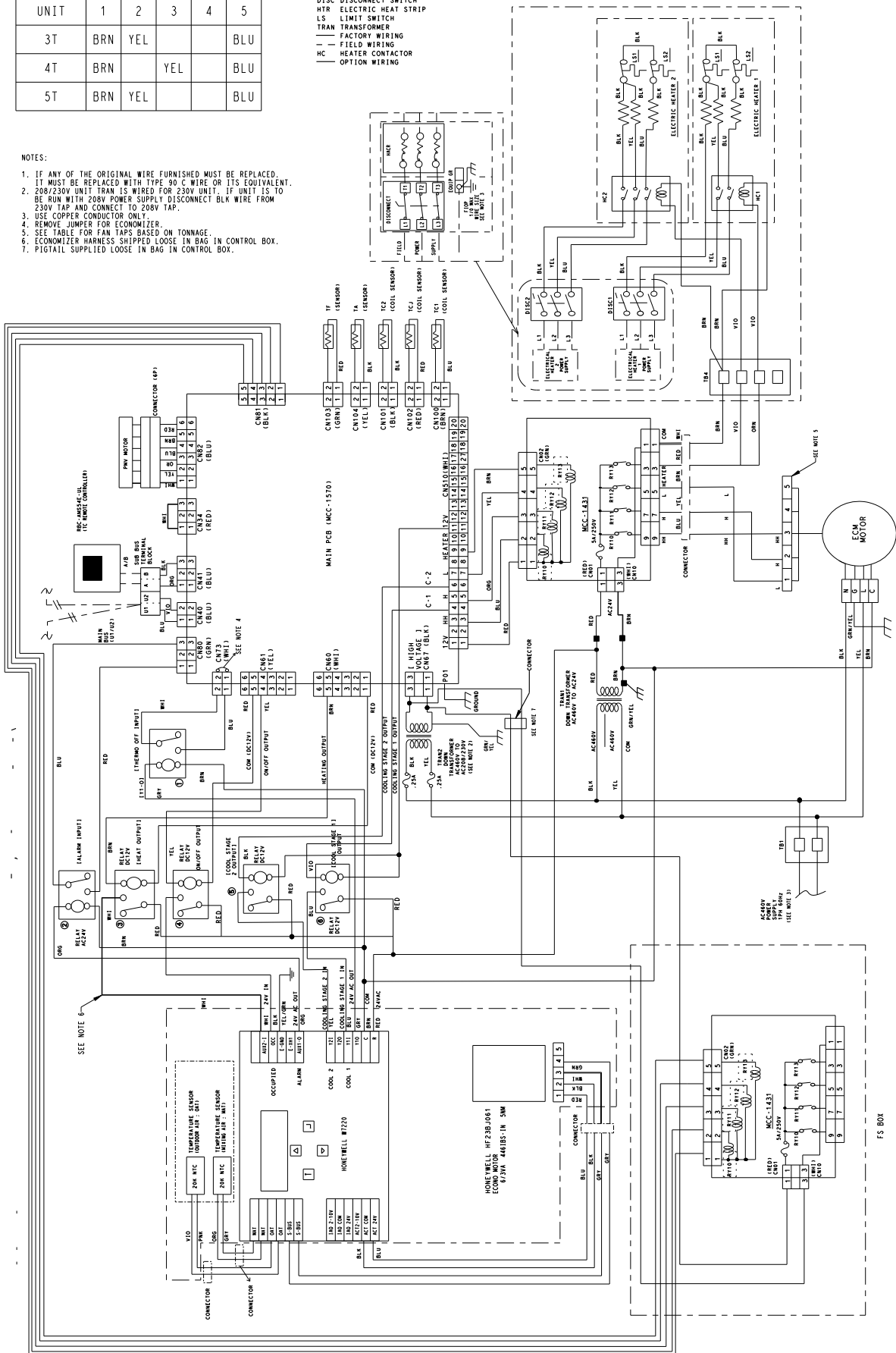

Fig. 10 - 40QQ Power Wiring Diagram, 460V, 60Hz

ELECTRICAL DATA

Table 14 – VRF RTU

Tonnage	Model Number	Voltage	MCA (A)*	MOCP (A)*
3	40QQ- 036AAA3- 0A0	208/230- 1- 60	8.00	15
	40QQ- 036AAAC- 0A0	460- 1- 60	4.00	15
4	40QQ- 048AAA3- 0A0	208/230- 1- 60	10.00	15
	40QQ- 048AAAC- 0A0	460- 1- 60	5.00	15
5	40QQ- 060AAA3- 0A0	208/230- 1- 60	10.00	15
	40QQ- 060AAAC- 0A0	460- 1- 60	5.00	15

* Without electric heaters. If electric heaters are used, refer to Tables 5 and 6.

LEGEND:

MCA- Minimum circuit amps

MOCP- MAX FUSE or HACR Breaker

NOTE: In compliance with NEC requirements for multimotor and combination load equipment (refer to NEC Articles 430 and 440), the overcurrent protective device for the unit shall be fuse or HACR breaker. Canadian units may be fuse or circuit breaker.

FAN PERFORMANCE

General Fan Performance Notes

1. Interpolation is permissible. Do not extrapolate.
2. External static pressure is static pressure difference between return duct and supply duct plus the static pressure caused by any accessories.
3. Tabular data accounts for pressure loss due to clean filters, unit casing, and wet coils. Factory options and accessories may add static pressure losses. Selection software is available through your salesperson to help select best motor/drive combination for application.
4. For information on electrical properties of Carrier motors, see the Electrical Information section of this document.
5. For more information on the performance limits of Carrier motors, see the Application Data section of this document.
6. The EPACT (Energy Policy Act) regulates energy requirements for specific types of indoor fan motors. Motors regulated by EPACT include any general purpose, T-frame (three-digit, 143 and larger), single-speed, foot mounted, polyphase, squirrel cage induction motors of NEMA (National Electrical Manufacturers Association) design A and B, manufactured for use in the United States. Ranging from 1 to 200 HP, these continuous-duty motors operate on 230 and 460 volt, 60 Hz power. If a motor does not fit into these specifications, the motor does not have to be replaced by an EPACT compliant energy-efficient motor. Variable-speed motors are exempt from EPACT compliance requirements.

3 Ton Fan Curve

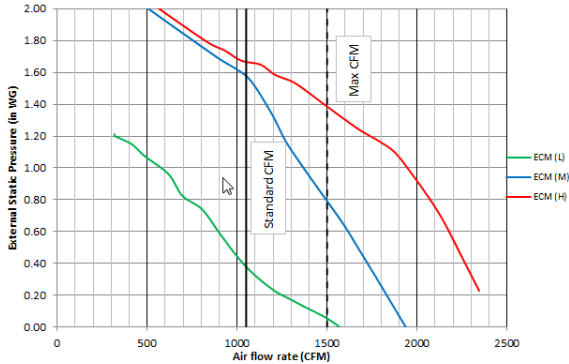

ECM (L)		ECM (M)		ECM (H)	
CFM	Static	CFM	Static	CFM	Static
317	1.21	395	2.10	288	2.24
321	1.20	480	2.02	406	2.14
413	1.15	893	1.69	485	2.07
486	1.07	983	1.63	833	1.79
618	0.96	1077	1.55	930	1.74
695	0.83	1194	1.34	1023	1.67
806	0.74	1270	1.17	1131	1.65
904	0.59	1363	1.01	1210	1.59
1008	0.43	1442	0.88	1314	1.54
1098	0.33	1583	0.66	1410	1.46
1206	0.23	1665	0.51	1498	1.39
1298	0.17	1776	0.30	1603	1.30
1384	0.12	1859	0.15	1690	1.23
1479	0.07			1794	1.17
1567	0.00			1879	1.09
				1971	0.96
				2067	0.81
				2153	0.65
				2246	0.45
				2345	0.23

4 Ton Fan Curve

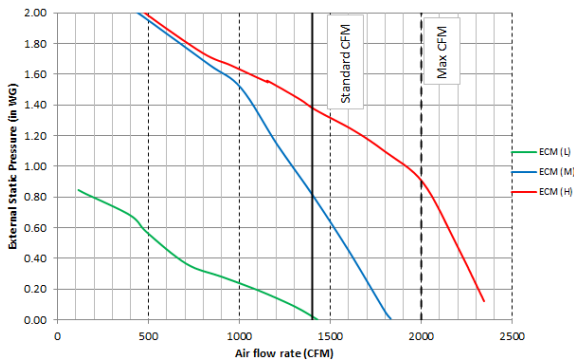

ECM (L)		ECM (M)		ECM (H)	
CFM	Static	CFM	Static	CFM	Static
113	0.85	125	2.32	384	2.10
148	0.82	375	2.06	487	1.99
398	0.68	491	1.96	797	1.74
492	0.57	829	1.67	955	1.66
707	0.36	1009	1.51	1155	1.55
899	0.28	1206	1.14	1152	1.56
1101	0.19	1395	0.82	1326	1.44
1304	0.09	1599	0.45	1422	1.37
1428	0.00	1803	0.05	1626	1.24
		1831	0.01	1799	1.10
				2009	0.89
				2193	0.49
				2345	0.12

5 Ton Fan Curve

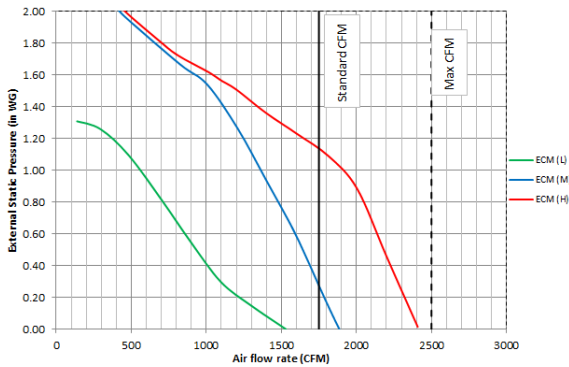

ECM (L)		ECM (M)		ECM (H)	
CFM	Static	CFM	Static	CFM	Static
1530	0.00	141	2.29	276	2.20
1301	0.15	399	2.02	379	2.08
1096	0.30	485	1.94	477	1.98
894	0.55	824	1.67	680	1.82
707	0.81	1006	1.54	807	1.73
481	1.10	1208	1.26	1017	1.62
295	1.26	1401	0.93	1106	1.56
139	1.31	1593	0.60	1198	1.51
		1796	0.18	1400	1.36
		1885	0.00	1601	1.23
				1814	1.09
				2004	0.88
				2197	0.47
				2408	0.01

Fan Performance - ECM (Multi-Speed) Indoor Motor

Table 15 – 40QQ-036 Direct Drive

Speed (Torque) Tap	Vertical Unit			Horizontal Unit		
	CFM	ESP	BHP	CFM	ESP	BHP
1	750	0.34	0.11	750	0.40	0.15
	900	0.18	0.11	900	0.23	0.14
	1050	-	-	1050	-	-
	1125	-	-	1125	-	-
	1200	-	-	1200	-	-
	1275	-	-	1275	-	-
	1350	-	-	1350	-	-
	1425	-	-	1425	-	-
2	750	0.55	0.18	750	0.67	0.23
	900	0.36	0.16	900	0.47	0.21
	1050	0.18	0.15	1050	0.29	0.19
	1125	0.10	0.15	1125	0.21	0.18
	1200	0.03	0.16	1200	0.13	0.18
	1275	-	-	1275	0.06	0.20
	1350	-	-	1350	-	-
	1425	-	-	1425	-	-
3	750	1.20	0.31	750	1.28	0.44
	900	1.00	0.39	900	1.11	0.44
	1050	0.79	0.38	1050	0.91	0.43
	1125	0.67	0.37	1125	0.80	0.42
	1200	0.56	0.35	1200	0.68	0.40
	1275	0.44	0.34	1275	0.56	0.39
	1350	0.32	0.32	1350	0.44	0.37
	1425	0.21	0.31	1425	0.32	0.36
4	750	1.35	0.45	750	1.39	0.48
	900	1.21	0.48	900	1.32	0.51
	1050	1.09	0.51	1050	1.23	0.55
	1125	1.03	0.53	1125	1.18	0.57
	1200	0.96	0.55	1200	1.11	0.59
	1275	0.88	0.57	1275	1.03	0.60
	1350	0.78	0.58	1350	0.94	0.62
	1425	0.68	0.57	1425	0.84	0.61
5	750	1.34	0.45	750	1.40	0.48
	900	1.21	0.48	900	1.32	0.51
	1050	1.09	0.53	1050	1.24	0.56
	1125	1.04	0.55	1125	1.19	0.58
	1200	1.00	0.57	1200	1.14	0.61
	1275	0.95	0.60	1275	1.10	0.63
	1350	0.90	0.62	1350	1.05	0.66
	1425	0.84	0.65	1425	0.99	0.68
1500	0.78	0.68	1500	0.94	0.71	

* To convert BHP to watts, use 84% motor efficiency.

LEGEND

BHP: Brake Horse Power

ESP: External Static Pressure

CFM: Cubic Feet per Minute

ECM: Electronically Communicated Motor

Fan Performance (Cont.)

Table 16 – 40QQ-048 Direct Drive

Speed (Torque) Tap	Vertical Unit			Horizontal Unit		
	CFM	ESP	BHP	CFM	ESP	BHP
1	1000	0.21	0.15	1000	0.23	0.15
	1200	0.11	0.10	1200	0.15	0.15
	1400	-	-	1400	0.06	0.17
	1500	-	-	1500	0.02	0.18
	1600	-	-	1600	-	-
	1700	-	-	1700	-	-
	1800	-	-	1800	-	-
	1900	-	-	1900	-	-
	2000	-	-	2000	-	-
2	1000	0.94	0.38	1000	1.02	0.42
	1200	0.68	0.35	1200	0.74	0.39
	1400	0.40	0.31	1400	0.46	0.35
	1500	0.24	0.28	1500	0.32	0.32
	1600	0.10	0.26	1600	0.19	0.30
	1700	-	-	1700	0.07	0.27
	1800	-	-	1800	-	-
	1900	-	-	1900	-	-
	2000	-	-	2000	-	-
3	1000	1.24	0.51	1000	1.33	0.54
	1200	1.18	0.55	1200	1.23	0.59
	1400	1.08	0.57	1400	1.05	0.63
	1500	1.01	0.61	1500	0.94	0.65
	1600	0.91	0.60	1600	0.81	0.62
	1700	0.78	0.58	1700	0.67	0.59
	1800	0.63	0.56	1800	0.52	0.56
	1900	0.46	0.53	1900	0.37	0.53
	2000	0.28	0.51	2000	0.22	0.50
4	1000	1.23	0.51	1000	1.32	0.54
	1200	1.13	0.57	1200	1.22	0.60
	1400	1.04	0.64	1400	1.12	0.67
	1500	1.00	0.74	1500	1.07	0.77
	1600	0.95	0.71	1600	1.02	0.74
	1700	0.89	0.74	1700	0.97	0.77
	1800	0.82	0.77	1800	0.91	0.81
	1900	0.73	0.79	1900	0.84	0.83
	2000	0.63	0.82	2000	0.76	0.86
5	1000	1.27	0.52	1000	1.35	0.55
	1200	1.16	0.59	1200	1.25	0.61
	1400	1.06	0.67	1400	1.15	0.68
	1500	1.01	0.67	1500	1.10	0.68
	1600	0.96	0.75	1600	1.05	0.76
	1700	0.91	0.75	1700	1.01	0.76
	1800	0.86	0.83	1800	0.96	0.84
	1900	0.80	0.87	1900	0.91	0.89
	2000	0.74	0.92	2000	0.87	0.93

* To convert BHP to watts, use 84% motor efficiency.

LEGEND

BHP: Brake Horse Power
 ESP: External Static Pressure
 CFM: Cubic Feet per Minute

Fan Performance (Cont.)

Table 17 – 40QQ-060 Direct Drive

Speed (Torque) Tap	Vertical			Horizontal		
	CFM	ESP	BHP	CFM	ESP	BHP
1	1250	0.19	0.18	1250	0.23	0.20
	1500	0.03	0.19	1500	0.10	0.22
	1750	-	-	1750	-	-
	1875	-	-	1875	-	-
	2000	-	-	2000	-	-
	2125	-	-	2125	-	-
	2250	-	-	2250	-	-
	2375	-	-	2375	-	-
	2500	-	-	2500	-	-
2	1250	1.06	0.57	1250	1.19	0.62
	1500	0.65	0.52	1500	0.80	0.57
	1750	0.27	0.47	1750	0.42	0.51
	1875	0.11	0.44	1875	0.24	0.48
	2000	-	-	2000	0.06	0.44
	2125	-	-	2125	-	-
	2250	-	-	2250	-	-
	2375	-	-	2375	-	-
	2500	-	-	2500	-	-
3	1250	1.38	0.73	1250	1.50	0.78
	1500	1.00	0.72	1500	1.17	0.77
	1750	0.60	0.67	1750	0.78	0.71
	1875	0.41	0.63	1875	0.57	0.67
	2000	0.22	0.60	2000	0.36	0.63
	2125	0.04	0.57	2125	0.17	0.59
	2250	-	-	2250	-	-
	2375	-	-	2375	-	-
	2500	-	-	2500	-	-
4	1250	1.50	0.82	1250	1.64	0.85
	1500	1.25	0.88	1500	1.42	0.92
	1750	0.89	0.87	1750	1.09	0.92
	1875	0.68	0.84	1875	0.90	0.90
	2000	0.46	0.80	2000	0.69	0.86
	2125	0.26	0.76	2125	0.47	0.81
	2250	0.08	0.73	2250	0.28	0.77
	2375	-	-	2375	0.11	0.73
	2500	-	-	2500	0.00	0.67
5	1250	1.55	0.85	1250	1.69	0.87
	1500	1.36	0.94	1500	1.52	0.97
	1750	1.10	1.02	1750	1.30	1.05
	1875	0.93	1.05	1875	1.16	1.09
	2000	0.74	1.03	2000	1.00	1.09
	2125	0.53	0.99	2125	0.82	1.06
	2250	0.31	0.94	2250	0.62	1.02
	2375	0.08	0.90	2375	0.40	0.98
	2500	-	-	2500	0.16	0.93

* To convert BHP to watts, use 84% motor efficiency.

BHP: Brake Horse Power
 ESP: External Static Pressure
 CFM: Cubic Feet per Minute

SOUND PERFORMANCE

Table 18 – Sound Performance

	A- Weighted	63	125	250	500	1000	2000	4000	8000
036	76	78.2	78.0	74.2	73.3	70.6	66.0	62.4	56.9
048	78	84.7	83.6	77.1	74.6	72.3	68.3	64.7	60.9
060	77	87.5	82.5	76.1	73.6	71.3	67.1	64.1	60.0

NOTES:

1. Measurements are expressed in terms of sound power. Do not compare these values to sound pressure values because sound pressure depends on specific environmental factors, which normally do not match individual applications. Sound power values are independent of the environment and are more accurate.
2. Sound data tested according to ANSI/AHRI Standard 260 (I- P).

LEGEND

dB - Decibel

APPLICATION DATA

Minimum operating ambient temp (cooling)

In mechanical cooling mode, your Carrier rooftop can safely operate down to an outdoor ambient temperature of 14°F DB (-12°C DB)

Maximum operating ambient temp (cooling)

The maximum operating ambient temperature for cooling mode is 122°F DB (50°C DB).

Minimum operating ambient temp (heating)

In mechanical heating mode, your Carrier rooftop can safely operate up to an outdoor ambient temperature of -13°F WB (-25°C WB)

Maximum operating ambient temp (heating)

The maximum operating ambient temperature for heating mode is 60° W DB (15.6°C WB).

Minimum / maximum airflow (cooling mode)

To maintain safe and reliable operation of your rooftop, operate within the cooling airflow limits. Operating above the maximum may cause blow-off, undesired airflow noise, or airflow related problems with the rooftop unit. Operating below the minimum may cause problems with coil freeze-up.

Airflow

All units are draw-through in cooling mode.

Outdoor air application strategies

Economizers reduce operating expenses and compressor run time by providing a free source of cooling and a means of ventilation to match application changing needs. In fact, they should be considered for most applications. Also, consider the various economizer control methods and their benefits, as well as sensors required to accomplish your application goals. Contact your local Carrier representative for assistance.

Motor limits, brake horsepower (BHP)

Due to Carrier’s internal unit design, air path, and specially designed motors, full horsepower (maximum continuous BHP) band can be used as listed in Tables 3. There is no need for extra safety factors, as Carrier’s motors are designed and rigorously tested to use the entire listed BHP range without nuisance tripping or premature motor failure.

Sizing a rooftop

An air conditioner needs to have enough capacity to meet the load, but it does not need excess capacity. Having excess capacity typically results in very poor part load performance and humidity control.

Signs of oversizing air conditioners:

- Using higher design temperatures than ASHRAE recommends for your location
- Adding “safety factors” to the calculated load
- Rounding up to the next largest unit

Oversizing can cause short-cycling. This leads to:

- Poor humidity control
- Reduced efficiency
- Higher utility bills
- Drastic indoor temperature swings
- Excessive noise
- Increased wear and tear on the air conditioner

Rather than oversizing an air conditioner, contractors and engineers “right-size” or even slightly undersize air conditioners. Correctly sizing an air conditioner helps control humidity, promotes efficiency, reduces utility bills, extends equipment life, and maintains even, comfortable temperatures.

ECONOMIZER, BAROMETRIC RELIEF, AND PE PERFORMANCE

Vertical Application

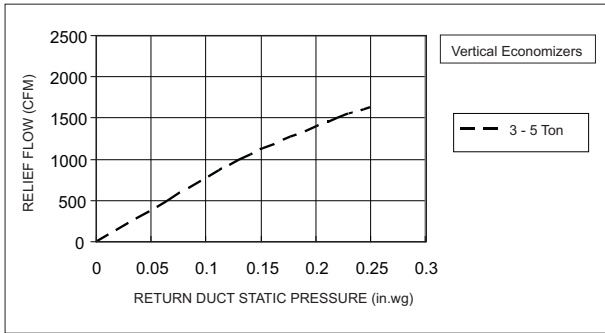

Fig. 11 - Barometric Relief Flow-Vertical 3-5 Ton

Horizontal Application

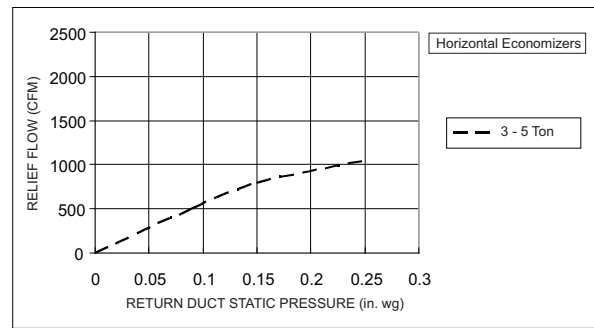

Fig. 13 - Barometric Relief Flow - Horizontal 3-5 Ton

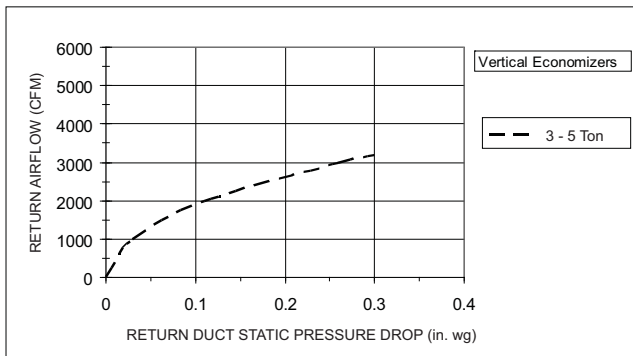

Fig. 12 - Return Air Pressure Drop-Vertical 3-5 Ton

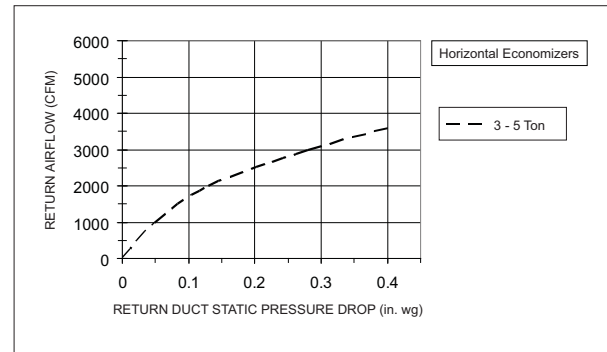

Fig. 14 - Return Air Pressure Drop - Horizontal 3-5 Ton

Table 19 – Static Pressure Adders (in. wg) - Factory Options and/or Accessories (Electric Heaters)

CFM	600	900	1200	1400	1600	1800	2000	2200	2400	2600
1 Electric Heater Module	0.03	0.05	0.07	0.09	0.09	0.10	0.11	0.11	0.12	0.13
2 Electric Heater Modules	0.13	0.15	0.16	0.16	0.16	0.17	0.17	0.17	0.18	0.18

This amount of phase imbalance is satisfactory as it is below the maximum allowable 2%.

IMPORTANT: If the supply voltage phase imbalance is more than 2%, contact your local electric utility company immediately.

CAPACITY TABLES

Table 20 – Cooling Capacity for 3-5 Ton Unit

TC : Total Capacity [Btu/h] SCH : Sensible Capacity [Btu/h]

		Indoor air temp.													
unit size	outdoor air temp.	59°F WB		61°F WB		64°F WB		67°F WB		68°F WB		72°F WB		75°F WB	
		71°F DB		73°F DB		77°F DB		80°F DB		82°F DB		86°F DB		90°F DB	
	°F DB	TC	SCH	TC	SCH	TC	SCH	TC	SCH	TC	SCH	TC	SCH	TC	SCH
036	50	30,640	22,850	32,060	23,470	34,090	24,430	36,000	25,200	36,620	25,270	38,930	24,950	40,540	24,020
	54	30,640	22,850	32,060	23,470	34,090	24,430	36,000	25,200	36,620	25,270	38,930	24,950	40,540	24,020
	57	30,640	22,850	32,060	23,470	34,090	24,430	36,000	25,200	36,620	25,270	38,930	24,950	40,540	24,020
	61	30,640	22,850	32,060	23,470	34,090	24,430	36,000	25,200	36,620	25,270	38,930	24,950	40,540	24,020
	64	30,640	22,850	32,060	23,470	34,090	24,430	36,000	25,200	36,620	25,270	38,930	24,950	40,540	24,020
	68	30,640	22,850	32,060	23,470	34,090	24,430	36,000	25,200	36,620	25,270	38,930	24,950	40,540	24,020
	70	30,640	22,850	32,060	23,470	34,090	24,430	36,000	25,200	36,620	25,270	38,930	24,950	40,540	24,020
	73	30,640	22,850	32,060	23,470	34,090	24,430	36,000	25,200	36,620	25,270	38,930	24,950	40,540	24,020
	77	30,640	22,850	32,060	23,470	34,090	24,430	36,000	25,200	36,620	25,270	38,930	24,950	40,540	24,020
	81	30,640	22,850	32,060	23,470	34,090	24,430	36,000	25,200	36,620	25,270	38,930	24,950	40,540	24,020
	84	30,640	22,850	32,060	23,470	34,090	24,430	36,000	25,200	36,620	25,270	38,930	24,950	40,540	24,020
	88	30,640	22,850	32,060	23,470	34,090	24,430	36,000	25,200	36,620	25,270	38,930	24,950	40,540	24,020
	91	30,640	22,850	32,060	23,470	34,090	24,430	36,000	25,200	36,620	25,270	38,930	24,950	40,540	24,020
	95	30,640	22,850	32,060	23,470	34,090	24,430	36,000	25,200	36,620	25,270	38,930	24,950	40,540	24,020
99	29,750	22,190	31,130	22,790	33,100	23,720	34,960	24,470	35,560	24,540	37,800	24,230	39,360	23,320	
102	29,050	21,660	30,390	22,250	32,320	23,160	34,130	23,890	34,720	23,960	36,910	23,650	38,430	22,770	
048	50	40,850	30,460	42,740	31,290	45,450	32,580	48,000	33,600	48,820	33,690	51,910	33,260	54,050	32,020
	54	40,850	30,460	42,740	31,290	45,450	32,580	48,000	33,600	48,820	33,690	51,910	33,260	54,050	32,020
	57	40,850	30,460	42,740	31,290	45,450	32,580	48,000	33,600	48,820	33,690	51,910	33,260	54,050	32,020
	61	40,850	30,460	42,740	31,290	45,450	32,580	48,000	33,600	48,820	33,690	51,910	33,260	54,050	32,020
	64	40,850	30,460	42,740	31,290	45,450	32,580	48,000	33,600	48,820	33,690	51,910	33,260	54,050	32,020
	68	40,850	30,460	42,740	31,290	45,450	32,580	48,000	33,600	48,820	33,690	51,910	33,260	54,050	32,020
	70	40,850	30,460	42,740	31,290	45,450	32,580	48,000	33,600	48,820	33,690	51,910	33,260	54,050	32,020
	73	40,850	30,460	42,740	31,290	45,450	32,580	48,000	33,600	48,820	33,690	51,910	33,260	54,050	32,020
	77	40,850	30,460	42,740	31,290	45,450	32,580	48,000	33,600	48,820	33,690	51,910	33,260	54,050	32,020
	81	40,850	30,460	42,740	31,290	45,450	32,580	48,000	33,600	48,820	33,690	51,910	33,260	54,050	32,020
	84	40,850	30,460	42,740	31,290	45,450	32,580	48,000	33,600	48,820	33,690	51,910	33,260	54,050	32,020
	88	40,850	30,460	42,740	31,290	45,450	32,580	48,000	33,600	48,820	33,690	51,910	33,260	54,050	32,020
	91	40,850	30,460	42,740	31,290	45,450	32,580	48,000	33,600	48,820	33,690	51,910	33,260	54,050	32,020
	95	40,850	30,460	42,740	31,290	45,450	32,580	48,000	33,600	48,820	33,690	51,910	33,260	54,050	32,020
99	39,670	29,580	41,500	30,380	44,130	31,640	46,610	32,630	47,400	32,710	50,400	32,300	52,480	31,090	
102	38,730	28,880	40,520	29,660	43,090	30,890	45,500	31,850	46,280	31,940	49,210	31,530	51,240	30,350	
060	50	51,070	38,080	53,430	39,120	56,810	40,720	60,000	42,000	61,030	42,120	64,890	41,580	67,560	40,020
	54	51,070	38,080	53,430	39,120	56,810	40,720	60,000	42,000	61,030	42,120	64,890	41,580	67,560	40,020
	57	51,070	38,080	53,430	39,120	56,810	40,720	60,000	42,000	61,030	42,120	64,890	41,580	67,560	40,020
	61	51,070	38,080	53,430	39,120	56,810	40,720	60,000	42,000	61,030	42,120	64,890	41,580	67,560	40,020
	64	51,070	38,080	53,430	39,120	56,810	40,720	60,000	42,000	61,030	42,120	64,890	41,580	67,560	40,020
	68	51,070	38,080	53,430	39,120	56,810	40,720	60,000	42,000	61,030	42,120	64,890	41,580	67,560	40,020
	70	51,070	38,080	53,430	39,120	56,810	40,720	60,000	42,000	61,030	42,120	64,890	41,580	67,560	40,020
	73	51,070	38,080	53,430	39,120	56,810	40,720	60,000	42,000	61,030	42,120	64,890	41,580	67,560	40,020
	77	51,070	38,080	53,430	39,120	56,810	40,720	60,000	42,000	61,030	42,120	64,890	41,580	67,560	40,020
	81	51,070	38,080	53,430	39,120	56,810	40,720	60,000	42,000	61,030	42,120	64,890	41,580	67,560	40,020
	84	51,070	38,080	53,430	39,120	56,810	40,720	60,000	42,000	61,030	42,120	64,890	41,580	67,560	40,020
	88	51,070	38,080	53,430	39,120	56,810	40,720	60,000	42,000	61,030	42,120	64,890	41,580	67,560	40,020
	91	51,070	38,080	53,430	39,120	56,810	40,720	60,000	42,000	61,030	42,120	64,890	41,580	67,560	40,020
	95	51,070	38,080	53,430	39,120	56,810	40,720	60,000	42,000	61,030	42,120	64,890	41,580	67,560	40,020
99	49,590	36,980	51,880	37,990	55,160	39,540	58,260	40,780	59,260	40,900	63,010	40,370	65,600	38,860	
102	48,410	36,100	50,650	37,090	53,860	38,600	56,880	39,820	57,860	39,930	61,520	39,420	64,050	37,940	

LEGEND:

- DB - dry bulb
- WB - wet bulb
- SCH - Sensible heat capacity
- TC - Total capacity

Table 21 – Heating Capacity for 3-5 Ton Unit

TC : Total Capacity [Btu/h]

Unit Size	Outdoor Air Temperature °FWB	Indoor Air Temperature						
		61°FDB	63°FDB	67°FDB	70°FDB	71°FDB	75°FDB	77°FDB
		TC	TC	TC	TC	TC	TC	TC
036	5	21,950	21,740	21,270	20,900	20,750	20,480	19,860
	10	23,500	23,280	22,780	22,380	22,220	21,930	21,260
	15	25,500	25,250	24,720	24,280	24,110	23,800	23,070
	20	27,890	27,620	27,040	26,560	26,370	26,030	25,230
	25	30,520	30,230	29,590	29,070	28,860	28,490	27,620
	30	33,200	32,880	32,180	31,620	31,390	30,980	30,040
	35	35,910	35,570	34,810	34,200	33,960	33,520	32,490
	43	39,900	39,520	38,680	38,000	37,730	37,240	36,100
	45	39,900	39,520	38,680	38,000	37,730	37,240	36,100
	50	39,900	39,520	38,680	38,000	37,730	37,240	36,100
	55	39,900	39,520	38,680	38,000	37,730	37,240	36,100
60	39,900	39,520	38,680	38,000	37,730	37,240	36,100	
048	5	30,030	29,740	29,120	28,600	28,400	28,030	27,170
	10	32,160	31,850	31,180	30,630	30,420	30,020	29,100
	15	34,890	34,560	33,830	33,230	33,000	32,560	31,570
	20	38,170	37,800	37,010	36,350	36,100	35,620	34,530
	25	41,770	41,370	40,500	39,780	39,500	38,980	37,790
	30	45,430	44,990	44,050	43,260	42,960	42,400	41,100
	35	49,140	48,670	47,650	46,800	46,480	45,860	44,460
	43	54,600	54,080	52,940	52,000	51,640	50,960	49,400
	45	54,600	54,080	52,940	52,000	51,640	50,960	49,400
	50	54,600	54,080	52,940	52,000	51,640	50,960	49,400
	55	54,600	54,080	52,940	52,000	51,640	50,960	49,400
60	54,600	54,080	52,940	52,000	51,640	50,960	49,400	
060	5	38,120	37,750	36,950	36,300	36,050	35,570	34,490
	10	40,820	40,430	39,570	38,870	38,600	38,100	36,930
	15	44,280	43,860	42,930	42,170	41,880	41,330	40,070
	20	48,440	47,980	46,970	46,130	45,810	45,210	43,830
	25	53,010	52,510	51,400	50,490	50,140	49,480	47,970
	30	57,660	57,110	55,900	54,910	54,530	53,810	52,170
	35	62,370	61,780	60,470	59,400	58,990	58,210	56,430
	43	69,300	68,640	67,190	66,000	65,540	64,680	62,700
	45	69,300	68,640	67,190	66,000	65,540	64,680	62,700
	50	69,300	68,640	67,190	66,000	65,540	64,680	62,700
	55	69,300	68,640	67,190	66,000	65,540	64,680	62,700
60	69,300	68,640	67,190	66,000	65,540	64,680	62,700	

LEGEND:

DB - dry bulb

WB - wet bulb

TC - Total capacity

Manufacturer reserves the right to discontinue, or change at any time, specifications or designs without notice and without incurring obligations.